

SOFTWARE INTERFACE CONTROL
DOCUMENT PART 1, INTERNATIONAL
STANDARD PAYLOAD RACK TO
INTERNATIONAL SPACE STATION

International Space Station Program

Revision B
November 27, 2000

National Aeronautics and Space Administration
International Space Station Program
Johnson Space Center
Houston, Texas
Contract No. NAS15-10000



REVISION AND HISTORY PAGE

REV.	DESCRIPTION	PUB. DATE
–	Initial Release per SSCD 000281, EFF. 07–20–96	05–23–97
A	Revision A (Reference per SSCD 001022, EFF. 08–25–98)	11–04–98
B	Revision B (Reference per SSCD 002495, EFF. 07–10–00) Revision B incorporates PIRN 52050–NA–0003B Revision A incorporated PIRN 52050–NA–0002D	12–08–00

ERU: /s/Beth Mason 12–08–00

PREFACE

This document in conjunction with SSP 57000, Pressurized Payloads Interface Requirements Document, and SSP 57003, Attached Payloads Interface Requirements Document, defines the minimum International Space Station Command and Data Handling requirements for International Standard Payload Racks and Attached Payloads. This document contains an introduction, a list of applicable documents, subsections on general and detailed interface and payload specific design requirements, along with appendices for MIL-STD-1553B bus timing profiles, acronyms, glossary of terms, and CCSDS header tailoring. The applicability of these requirements will depend upon the characteristics of the integrated rack or pallet payloads as specified in the individual Payload Integration Agreement (PIA). The interface requirements outlined in this document are mandatory and may not be violated unless specifically agreed upon in the individual Software Interface Control Document.

INTERNATIONAL SPACE STATION PROGRAM
SOFTWARE INTERFACE CONTROL DOCUMENT, PART 1 ,
INTERNATIONAL STANDARD PAYLOAD RACK TO INTERNATIONAL SPACE

NOVEMBER 27, 2000

CONCURRENCE

APPROVED BY:	<u>Doug Craig</u> PRINT NAME	<u>Boeing Prime</u> ORGN
	<u>/s/ Doug Craig</u> SIGNATURE	<u>11/30/00</u> DATE

APPROVED BY:	<u>A. Gerald Esquivel</u> PRINT NAME	<u>NASA – OZ3</u> ORGN
	<u>/s/ A. Gerald Esquivel</u> SIGNATURE	<u>11/30/00</u> DATE

CONCURRENCE:	<u>Craig A. Davidson</u> PRINT NAME	<u>NASA – OD</u> ORGN
	<u>/s/ Craig A. Davidson</u> SIGNATURE	<u>11/30/00</u> DATE

DQA CONCURRENCE	<u>Doug Craig</u> PRINT NAME	<u>Boeing Prime</u> ORGN
	<u>/s/ Doug Craig</u> SIGNATURE	<u>11/30/00</u> DATE

INTERNATIONAL SPACE STATION PROGRAM
SOFTWARE INTERFACE CONTROL DOCUMENT, PART 1 ,
INTERNATIONAL STANDARD PAYLOAD RACK TO INTERNATIONAL SPACE STATION

LIST OF CHANGES

27 NOV 2000

All changes to paragraphs, tables, and figures in this document are shown below:

SSCBD	ENTRY DATE	CHANGE	PARAGRAPH(S)
001022	25-Aug-98	52050-NA-0002D	2.2.2, 3.0, 3.1.3.1.1 3.1.3.1.1.1, 3.2.2.1, 3.2.2.2 3.2.3.1, 3.2.3.2.1.5, 3.2.3.2.1.5.1 3.2.3.2.1.5.2, 3.2.3.2.1.5.4 3.2.3.2.1.5.5, 3.2.3.2.1.5.6 3.2.3.2.1.5.7, 3.2.3.2.1.5.8 3.2.3.2.1.5.9, 3.2.3.2.1.5.10 3.2.3.2.1.5.11, 3.2.3.2.1.5.12 3.2.3.2.1.5.13, 3.2.3.2.1.5.14 3.2.3.2.1.5.15 3.2.3.2.2.1, 3.2.3.2.2.4 3.2.3.2.2.5, 3.2.3.2.2.8 3.2.3.2.2.9, 3.2.3.2.2.10 3.2.3.4, 3.2.3.4.1, 3.2.3.4.2, 3.2.3.5 3.2.3.5.1, 3.2.3.5.1.1 3.2.3.5.1.2, 3.2.3.5.2 3.2.3.5.3, 3.2.3.6, 3.2.3.7 3.2.3.8, 3.2.3.8.1, 3.2.3.8.2 3.2.3.9, 3.2.3.9.1, 3.2.3.9.2 3.2.3.10, 3.2.3.11, 3.2.3.12 TABLE(S) 3.2.3.2.1.4-1, 3.2.3.2.1.5-1 3.2.3.4-1, 3.2.3.5-1 3.2.3.7-1, 3.2.3.7-2 3.2.3.7.3, 3.2.3.8-1

SSCBD	ENTRY DATE	CHANGE	PARAGRAPH(S)
		52050-NA-0002D (Continued)	FIGURE(S) 3.0-1, 3.2.3.3.1-1, 3.2.3.5-1 3.2.3.5-2, 3.2.3.5-3 3.2.3.9.1-1, 3.2.3.10-1 APPENDIX(CES) Appendix C Appendix D ADDENDA N/A
002495	10-Jul-00	52050-NA-0003B	PARAGRAPH(S) 3.1.3.2, 3.2, 3.2.3.2.1.6 3.2.3.4, 3.2.3.5, 3.2.3.5.1 3.2.3.5.1.1, 3.2.3.5.1.2 3.2.3.7, 3.2.3.8.1, 3.2.3.8.2 3.2.3.9, 3.2.3.9.1, 3.2.3.9.2 3.2.3.10, 3.2.3.11, 3.3.3.6 FIGURE(S) 3.2.3.5-1, 3.2.3.5-2 3.2.3.9-1 TABLE(S) 3.2.3.5-1, 3.2.3.7-1 3.2.3.7-2, 3.2.3.7-3 3.3.3.6-1 APPENDIX(CES) Appendix B B-1 thru B-3 Appendix D D-1 thru D-2 ADDENDA N/A

TABLE OF CONTENTS

PARAGRAPH		PAGE
1.0	INTRODUCTION	1 - 1
1.1	PURPOSE & SCOPE	1 - 1
1.2	PRECEDENCE	1 - 1
1.3	RESPONSIBILITY AND CHANGE AUTHORITY	1 - 1
2.0	APPLICABLE AND REFERENCE DOCUMENTS	2-1
2.1	APPLICABLE DOCUMENTS	2-1
2.1.1	STANDARDS	2-1
2.1.2	SPECIFICATIONS	2-1
2.1.3	OTHER DOCUMENTS	2-1
2.2	REFERENCE DOCUMENTS	2-1
2.2.1	STANDARDS	2-2
2.2.2	SPECIFICATIONS	2-2
2.2.3	OTHER DOCUMENTS	2-2
3.0	ISPR SOFTWARE INTERFACES TO US PAYLOAD DATA HANDLING EQUIPMENT	3 - 1
3.1	DATA FORMATS AND STANDARDS	3 - 1
3.1.1	NOTATIONS	3 - 1
3.1.2	DATA TRANSMISSION	3 - 3
3.1.3	CCSDS FORMATS	3 - 3
3.1.3.1	CCSDS PRIMARY HEADER FORMAT	3 - 3
3.1.3.2	CCSDS SECONDARY HEADER FORMAT	3 - 4
3.2	MIL-STD-1553B INTERFACE	3 - 4
3.2.1	DATA FORMATS	3 - 4
3.2.1.1	OCTET	3 - 5
3.2.1.2	SIGNED INTEGERS	3 - 5
3.2.1.3	UNSIGNED INTEGERS	3 - 5
3.2.1.4	FLOATING POINT	3 - 5
3.2.1.5	ENUMERATION TYPE	3 - 5
3.2.1.6	BOOLEAN TYPE	3 - 5
3.2.1.7	CHARACTER TYPE	3 - 5
3.2.1.8	BITSET	3 - 6
3.2.1.9	DURATION	3 - 6
3.2.1.10	STRINGS	3 - 6
3.2.2	TIME CODES	3 - 6
3.2.2.1	SEGMENTED TIME CODES	3 - 6
3.2.2.2	UNSEGMENTED TIME CODES	3 - 6
3.2.3	LAYER 2 PROTOCOL	3 - 6
3.2.3.1	GENERAL	3 - 7
3.2.3.2	WORD INTERFACE	3 - 7
3.2.3.2.1	COMMAND WORD INTERFACE	3 - 7
3.2.3.2.1.1	SYNC	3 - 7
3.2.3.2.1.2	REMOTE TERMINAL ADDRESS	3 - 8
3.2.3.2.1.3	TRANSMIT/RECEIVE BIT	3 - 8
3.2.3.2.1.4	SUBADDRESS/MODE (SAM) FIELD	3 - 8
3.2.3.2.1.5	DATA WORD COUNT/MODE CODE	3 - 10
3.2.3.2.1.5.1	DYNAMIC BUS CONTROL	3 - 11
3.2.3.2.1.5.2	SYNCHRONIZE (W/O DATA WORDS)	3 - 11

3.2.3.2.1.5.3	TRANSMIT STATUS WORD	3 – 11
3.2.3.2.1.5.4	INITIATE SELF TEST	3 – 11
3.2.3.2.1.5.5	TRANSMITTER SHUTDOWN (SD)	3 – 11
3.2.3.2.1.5.6	OVERRIDE TRANSMITTER SD	3 – 11
3.2.3.2.1.5.7	INHIBIT TERMINAL FLAG	3 – 11
3.2.3.2.1.5.8	OVERRIDE INHIBIT TERMINAL FLAG	3 – 12
3.2.3.2.1.5.9	RESET REMOTE TERMINAL	3 – 12
3.2.3.2.1.5.10	TRANSMIT VECTOR WORD	3 – 12
3.2.3.2.1.5.11	SYNCHRONIZE (WITH DATA WORD)	3 – 12
3.2.3.2.1.5.12	TRANSMIT LAST COMMAND	3 – 12
3.2.3.2.1.5.13	TRANSMIT BIT WORD	3 – 12
3.2.3.2.1.5.14	SELECTED TRANSMITTER SHUTDOWN	3 – 12
3.2.3.2.1.5.15	OVERRIDE SELECTED TRANSMITTER SHUTDOWN	3 – 13
3.2.3.2.1.6	PARITY	3 – 13
3.2.3.2.2	STATUS WORD INTERFACE	3 – 13
3.2.3.2.2.1	SYNC	3 – 13
3.2.3.2.2.2	REMOTE TERMINAL ADDRESS	3 – 13
3.2.3.2.2.3	MESSAGE ERROR BIT	3 – 13
3.2.3.2.2.4	INSTRUMENTATION BIT	3 – 13
3.2.3.2.2.5	SERVICE REQUEST BIT	3 – 14
3.2.3.2.2.6	RESERVED	3 – 14
3.2.3.2.2.7	BROADCAST COMMAND RECEIVED BIT	3 – 14
3.2.3.2.2.8	SUBSYSTEM FLAG BIT	3 – 14
3.2.3.2.2.9	MIL–STD–1553B BUSY BIT	3 – 14
3.2.3.2.2.10	DYNAMIC MIL–STD–1553B CONTROL ACCEPTANCE BIT	3 – 14
3.2.3.2.2.11	TERMINAL FLAG BIT	3 – 14
3.2.3.2.2.12	PARITY	3 – 14
3.2.3.2.3	DATA WORD INTERFACE	3 – 15
3.2.3.2.3.1	SYNC	3 – 15
3.2.3.2.3.2	DATA	3 – 15
3.2.3.2.3.3	PARITY	3 – 15
3.2.3.3	STANDARD MESSAGES	3 – 16
3.2.3.3.1	RECEIVE DATA MESSAGE (BC TO RT)	3 – 16
3.2.3.3.2	TRANSMIT DATA MESSAGE (RT TO BC)	3 – 17
3.2.3.4	COMMANDING	3 – 18
3.2.3.4.1	PAYLOAD COMMANDING SERVICE CONSTRAINTS	3 – 19
3.2.3.4.2	PAYLOAD COMMANDING SERVICE ASSUMPTIONS	3 – 19
3.2.3.5	HEALTH AND STATUS DATA	3 – 20
3.2.3.5.1	LIMIT EXCEPTION SERVICE	3 – 26
3.2.3.5.1.1	LIMIT EXCEPTION SERVICE DATA TYPES	3 – 27
3.2.3.5.1.1	LIMIT EXCEPTION SERVICE CONSTRAINTS	3 – 28
3.2.3.5.2	HEALTH AND STATUS SERVICE CONSTRAINTS	3 – 28
3.2.3.5.2	HEALTH AND STATUS SERVICE ASSUMPTIONS	3 – 28
3.2.3.6	SAFETY DATA	3 – 29
3.2.3.7	SERVICE REQUESTS	3 – 30
3.2.3.8	ANCILLARY DATA	3 – 35
3.2.3.8.1	BROADCAST ANCILLARY DATA	3 – 35
3.2.3.8.1	UNIQUE ANCILLARY DATA SETS	3 – 35
3.2.3.9	FILE TRANSFER	3 – 38
3.2.3.9.1	ISPR TO PEP FILE TRANSFER (PEP FILE WRITE)	3 – 40

3.2.3.9.2	PEP TO ISPR FILE TRANSFER (PEP FILE READ)	3 – 42
3.2.3.10	LOW RATE TELEMETRY	3 – 44
3.2.3.11	PROCEDURE EXECUTION	3 – 47
3.2.3.12	BROADCAST TIME	3 – 48
3.3	MEDIUM RATE DATA LINK (MRDL)	3 – 49
3.3.1	MRDL CARRIER SENSED MULTIPLE ACCESS WITH COLLISION DETECTION (CSMA/CD) PROTOCOL	3 – 49
3.3.2	ISPR MRDL CONNECTIVITY	3 – 49
3.3.3	MRDL FRAME FORMAT	3 – 50
3.3.3.1	TRANSMISSION ORDER	3 – 50
3.3.3.2	PREAMBLE FIELD	3 – 51
3.3.3.3	START FRAME DELIMITER FIELD	3 – 51
3.3.3.4	ADDRESSES FIELDS	3 – 51
3.3.3.4.1	ADDRESS FIELD LENGTH	3 – 51
3.3.3.4.2	ADDRESS TYPE	3 – 52
3.3.3.4.3	BROADCAST ADDRESS FIELD	3 – 52
3.3.3.4.4	DESTINATION ADDRESS FIELD	3 – 52
3.3.3.4.5	SOURCE ADDRESS FIELD	3 – 52
3.3.3.5	FLOW CONTROL ADDRESS	3 – 53
3.3.3.6	ADDRESS ADMINISTRATION	3 – 53
3.3.3.7	LENGTH FIELD	3 – 54
3.3.3.8	USER DATA FIELD	3 – 54
3.3.3.9	PAD FIELD	3 – 54
3.3.3.10	FRAME CHECK SEQUENCE FIELD	3 – 54
3.3.4	GATEWAY PROTOCOL	3 – 54
3.3.4.1	BUFFER FULL MESSAGE	3 – 56
3.3.4.2	BUFFER FLOW CONTROL MESSAGE	3 – 56
3.3.4.3	INTERFRAME GAP	3 – 56
3.4	HIGH RATE DATA LINK (HRDL)	3 – 56
3.4.1	SIGNALING	3 – 57
3.4.1.1	DATA ENCODING	3 – 57
3.4.1.2	CONTROL SYMBOL	3 – 58
3.4.1.2.1	SYNC SYMBOL	3 – 59
3.4.1.2.1.1	START DELIMITER SYMBOLS	3 – 59
3.4.1.2.1.2	END DELIMITER SYMBOLS	3 – 59
3.4.1.2.2	DELIMITER SYMBOLS AND LINE STATES	3 – 59
3.4.1.2.2.1	SYMBOLS USED IN TESTING	3 – 59
3.4.1.3	INVALID SYMBOLS	3 – 60
3.4.2	HRDL PROTOCOL REQUIREMENTS	3 – 61
3.4.2.1	STATION-TO-STATION MODE	3 – 61
3.4.2.1.1	INITIALIZATION STATE	3 – 62
3.4.2.1.2	LOCK-ON STATE	3 – 62
3.4.2.2	DATA_SEND STATE	3 – 63
3.4.2.2.1	DATA RATE	3 – 63
3.4.2.2.2	EVENLY-PARSED DATA	3 – 63
3.4.2.3	HRFM MODES	3 – 64
3.4.2.4	HRFM PROTOCOL COMMON RULES	3 – 64
3.4.2.4.1	DATA RATES	3 – 65
3.4.2.4.2	DATA RATES FROM THE HRDL TO THE HRFM	3 – 65
3.4.2.4.3	ALLOCATED DATA RATES	3 – 65

3.4.2.4.4	BURST DATA RATES	3 – 65
3.4.2.4.4.1	EVENLY-PARSED DATA	3 – 65
3.4.2.4.5	HRFM MODE STATES	3 – 66
3.4.2.4.6	INITIALIZATION STATE	3 – 67
3.4.2.4.7	LOCK-ON STATE	3 – 67
3.4.2.4.8	DATA-SEND STATE	3 – 68
3.4.2.4.9	RECONFIGURE STATE	3 – 68
3.4.2.5	HRFM BITSTREAM MODE RULES	3 – 68
APPENDIX A	PAYLOAD MDM LOCAL BUS PROFILES	A – 1
APPENDIX B	ABBREVIATIONS AND ACRONUMS	B – 1
APPENDIX C	GLOSSARY OF TERMS	C – 1
APPENDIX C	SUMMARY OF CCSDS SECONDARY HEADER TAILORING	D – 1

FIGURES

3-1	ISPR SOFTWARE INTERFACES TO US PAYLOAD DATA HANDLING EQUIPMENT	3 - 1
3.1.1-1	MIL-STD-1553B BIT NAMING CONVENTION	3 - 2
3.1.3.1-1	CCSDS PRIMARY HEADER FORMAT	3 - 3
3.1.3.2-1	CCSDS SECONDARY HEADER FORMAT	3 - 4
3.2.3.3.1-1	RECEIVE DATA MESSAGE	3 - 16
3.2.3.3.2-1	TRANSMIT DATA MESSAGE	3 - 17
3.2.3.5-1	SINGLE SUBSET ID HEALTH AND STATUS FORMAT	3 - 21
3.2.3.5-2	ISPR HEALTH AND STATUS FORMAT	3 - 22
3.2.3.5-3	HEALTH AND STATUS UPDATE	3 - 26
3.2.3.9.1-1	FILE TRANSFER DATA UPDATE	3 - 42
3.2.3.10-1	LOW RATE TELEMETRY DATA UPDATE	3 - 46
3.3.3-1	MRDL FRAME FORMAT	3 - 50
3.3.3.1-1	MRDL TRANSMISSION ORDER	3 - 51
3.3.3.4.1-1	I48 BIT ADDRESS FORMAT	3 - 52
3.3.4-1	MRDL TO HRFM GATEWAY FLOW	3 - 55
3.4-1	TYPICAL HIGH RATE DATA LINK	3 - 57
3.4.2.1-1	HRDL STATION-TO-STATION MODE STATE DIAGRAM	3 - 62
3.4.2.2.2-1	EXAMPLE OF EVENLY PARSED DATA	3 - 64
3.4.2.3-1	TYPICAL STATION-TO-HRFM HIGH RATE DATA LINK	3 - 64
3.4.2.4.4.1-1	EXAMPLE OF EVENLY-PARSED DATA ON HRDL	3 - 66
3.4.2.4.2-1	MODE STATE DIAGRAM FOR HRFM MODES	3 - 67
3.4.2.5-1	HIGH RATE DATA LINK BITSTREAM FORMAT	3 - 69

TABLES

3.2.3.2.1.4-1	SUBADDRESS ASSIGNMENTS	3 - 9
3.2.3.2.1.5-1	MODE CODES	3 - 10
3.2.3.3.1-1	RECEIVE DATA MESSAGE FORMAT	3 - 16
3.2.3.3.2-1	TRANSMIT DATA MESSAGE FORMAT	3 - 17
3.2.3.4-1	COMMAND PACKET FORMAT	3 - 19
3.2.3.5-1	HEALTH AND STATUS PACKET FORMAT	3 - 25
3.2.3.7-1	SERVICE REQUESTS	3 - 30
3.2.3.7-2	REQUEST RESPONSE PACKET FORMAT	3 - 32
3.2.3.7-3	PAYLOAD REQUEST RESPONSE FAULT CODE VALUES	3 - 33
3.2.3.8-1	ANCILLARY DATA PACKET FORMAT	3 - 37
3.2.3.9-1	FILE DATA PACKET FORMAT	3 - 39
3.2.3.10-1	LOW-RATE TELEMETRY PACKET FORMAT	3 - 45
3.3.3.6-1	ISS MRDL 'STATION' ADDRESS	3 - 53
3.4.1.1-1	DATA ENCODING	3 - 58
3.4.1.2-1	CONTROL SYMBOLS	3 - 59
3.4.1.2.2-1	CONTROL INDICATORS	3 - 60
3.4.1.2.2-2	STARTING AND ENDING DELIMITERS	3 - 60
3.4.1.2.2-3	LINE STATES	3 - 60
3.4.1.3-1	INVALID SYMBOLS	3 - 61

1.0 INTRODUCTION

1.1 PURPOSE & SCOPE

The purpose of this document is to provide definition of the software interface requirements between the International Standard Payload Rack (ISPR) end item and the ISS flight elements. The scope of this document is limited to the software interfaces between ISPR and ISS flight elements.

1.2 PRECEDENCE

In the event of conflict between SSP 41162, United States On-orbit Segment (USOS) Specification, and the contents of this Interface Control Document (ICD), the requirements of the USOS Specification shall take precedence.

1.3 RESPONSIBILITY AND CHANGE AUTHORITY

This document is prepared and maintained in accordance with SSP30459, International Interface Control Plan.

2.0 APPLICABLE AND REFERENCE DOCUMENTS

2.1 APPLICABLE DOCUMENTS

The following documents, of the exact issue shown, form a part of this document to the extent specified herein.

2.1.1 STANDARDS

MIL-STD-1553B Digital Time Division Command/Response Multiplex Data Bus
Notice 2
8 September 1986

ISO/IEC 8802-3 Information Technology – Local and Metropolitan Area Networks,
formerly known as ANSI/IEEE 802.3

2.1.2 SPECIFICATIONS

SSP 41162 United States On-orbit Segment Specification
Revision E
3 July 1996

2.1.3 OTHER DOCUMENTS

SSP30459 International Interface Control Plan
Revision F
11 November 1995

SSP 41175 Book 2 Software Interface Control Document Part 1, Station Management and
Revision B Control to International Space Station Book 2, General Software
30 June 1997 Interface Requirements

CCSDS 701.0-B-2 Consultative Committee for Space Data Systems: Recommendation
Blue Book for Space Data Systems Standards; Advanced Orbiting Systems,
November 1992 Networks and Data Links: Architectural Specification

2.2 REFERENCE DOCUMENTS

The following documents are referenced in this ICD. In the event of a conflict between the documents referenced, and this document, the contents of this document are considered the controlling information.

2.2.1 STANDARDS

2.2.2 SPECIFICATIONS

SSP 50193-1 Software Interface Control Document, Part 1,
Original Payload Multiplexer/Demultiplexer to ISS, Book 1
October 1996

SSP 41002 International Standard Payload Rack to NASA/ESA/NASDA
Revision G Modules Interface Control Document
June 1997

SSP 57002 Payload Software Interface Control Document Template
Original
May 1998

2.2.3 OTHER DOCUMENTS

3.0 ISPR SOFTWARE INTERFACES TO US PAYLOAD DATA HANDLING EQUIPMENT

The ISPR to Station Command and Data Handling (C&DH) interface is composed of a 1553B Local Bus connection to the Payload MDM and a connection to the onboard High Rate Data Link (HRDL). Additionally, for ISPRs inside the US lab, a connection to each of two onboard Ethernet medium rate Local Area Networks (LAN), US-LAN 1 and US-LAN 2, is available. For ISPRs inside the Japanese Experiment Module (JEM) and the European Attached Pressurized Module (APM), there is only one connection to onboard Ethernet LAN services. The ISPR software interfaces to US payload data handling equipment is shown in Figure 3-1.

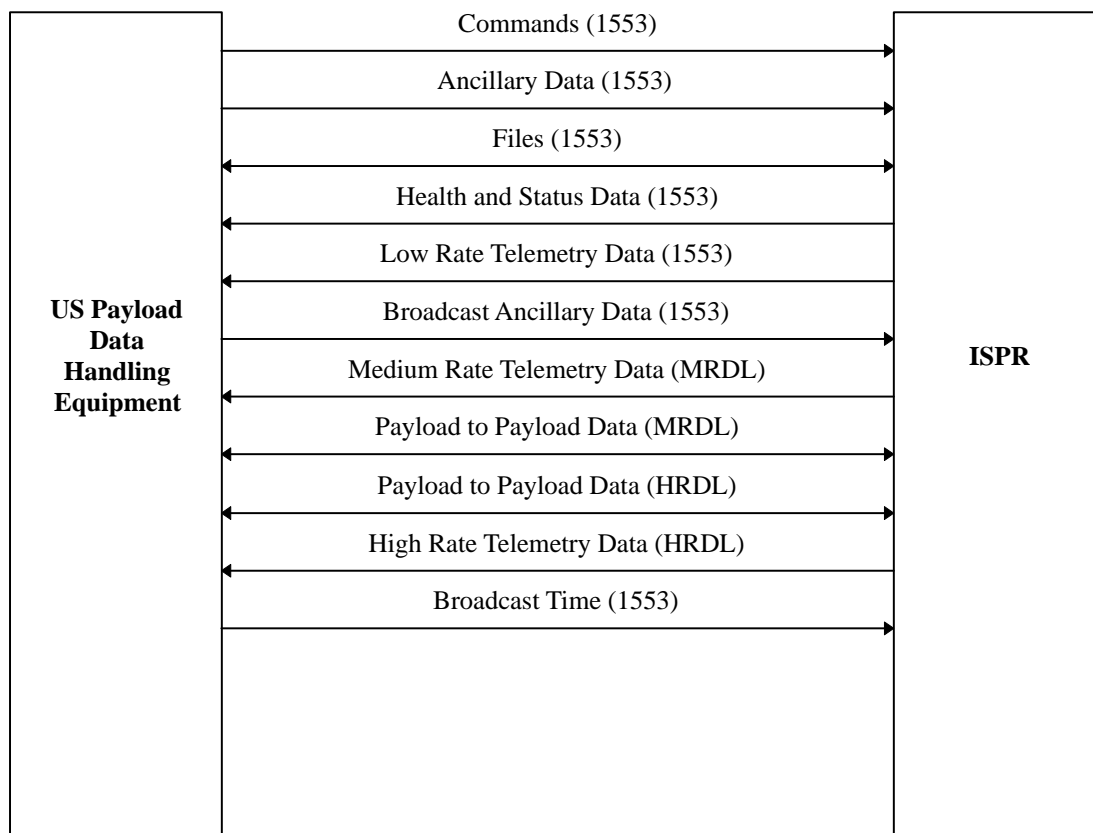

FIGURE 3-1 ISPR SOFTWARE INTERFACES TO US PAYLOAD DATA HANDLING EQUIPMENT

3.1 DATA FORMATS AND STANDARDS

3.1.1 NOTATIONS

The following notations are used in this document:

Binary Notation	'<value>' B	e.g. '1010' B
Octal Notation	'<value>' O	e.g. '1674' O
Hexadecimal Notation	'<value>' H	e.g. 'AB1F' H
Decimal Notation	<value>	e.g. 20.

The following nomenclature is used to describe contiguous groups of bits within a data packet:

1 byte	= 8 bits	= 1 octet	
1 bit	= 1b	=	=
1 byte	= 1B	=	=
1 word	= 2 bytes	= 2 octets	= 16 bits
1 double word	= 4 bytes	= 4 octets	= 32 bits
1 kilobit	= 1 Kb	= 1024 bits	=
1 kilobyte	= 1 KB	= 1024 bytes	=
1 megabit	= 1 Mb	= 1024 Kb	=
1 megabyte	= 1 MB	= 1024 KB	=

The following convention is used to identify each bit in an MIL-STD-1553B N-bit field and illustrated in Figure 3.1.1-1.

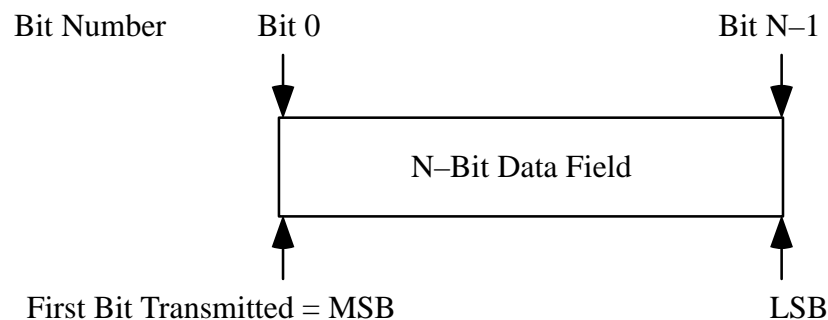

FIGURE 3.1.1-1 MIL-STD-1553B BIT NAMING CONVENTIONS

The first bit in a field, starting from the left is defined to be “Bit 0” and will be represented as the left most justified bit on a figure. The following bit is called “Bit 1”, and so on, up to “Bit N-1”, the bits being represented in this order from the left to right in the figure.

When the N-bit field is to be interpreted as a “Signed Integer”, Bit 0 will indicate the sign with Bit 0 = ‘0’ B corresponding to a positive number and Bit 0 = ‘1’ B corresponding to a negative number according to the “2’s complement” convention.

3.1.2 DATA TRANSMISSION

This section applies to payload data transmissions where the data will be processed by ISS systems (Payload MDM, Command and Control MDM, etc.). The MSB is always transmitted first. The data transmitted is as defined in MIL-STD-1553B, 4.3.2.

3.1.3 CCSDS FORMATS

The US Lab provides a logical interface to each ISPR location via the Standard Payload MIL-STD-1553B, the Payload Medium Rate Data Link, and the High Rate Data Link (HRDL). On each interface, the US Lab provides the Consultative Committee for Space Data Systems (CCSDS) path service protocol as the logical interface. The CCSDS Protocol is in accordance with section 3.3.3 of CCSDS 701.0-B-2 path protocol data unit (PDU) in entirety, except as noted in this ICD or as modified by a ISS document referenced from this ICD. In addition, the HRDL accommodates private bit-stream interfaces.

For each interface, the CCSDS path service is provided layered above the Physical Layer and the minimum required Protocol Layer as described in the following subsections.

3.1.3.1 CCSDS PRIMARY HEADER FORMAT

The US Lab provides data to and receives data from ISPR locations in the form of CCSDS packets. The first six octets of each packet are the CCSDS Primary Header as shown in Figure 3.1.3.1-1, CCSDS Primary Header Format. Field definitions for the primary header are per section 3.3.2.1.1 of SSP 41175-2, Software Interface Control Document, Part 1, Station Management and Control to International Space Station, Book 2, General Software Interface Requirements.

Primary Header						User Data Field
Packet Identification				Sequence Control		Packet Length
Version	Type	Secondary Header Flag	APID	Sequence Flags	Sequence Count	
3 bits	1 bit	1 bit	11 bits	2 bits	14 bits	16 bits
6 Octets						Var

FIGURE 3.1.3.1-1 CCSDS PRIMARY HEADER FORMAT

3.1.3.2 CCSDS SECONDARY HEADER FORMAT

The CCSDS secondary header is required for MIL-STD-1553B data transfers and for all telemetry packets on the KU-Band including Payload Medium Rate Data Link (MRDL) and High Rate Data Link (HRDL) telemetry transfers. The format of the CCSDS Secondary Header is illustrated in Figure 3.1.3.2-1, CCSDS Secondary Header Format. Field definitions for the secondary header are defined in Section 3.3.2.1.1 of SSP 41175-2, and are tailored as shown in Appendix D of this document. CCSDS headers are optional for payload-to-payload transfers on the MRDL and HRDL.

CCSDS Primary Header	User Data Field					
	Secondary Header					
	Time	User Data Control Field				Packet ID
		Time ID	Check sum Indi cator	Spare	Packet Type	
5 octets	2 bits	1 bit	1 bit	4 bits	4 octets	
6 octets	10 octets					

Figure 3.1.3.2-1 CCSDS Secondary Header Format

3.2 MIL-STD-1553B INTERFACE

The MIL-STD-1553B data interface provides the transfer of commands, request responses, ancillary data, files and time from the ISS to payloads and the transfer of payload health and status data, safety data, files, low rate telemetry, and requests for services from payloads to the ISS. The data formats, protocols, and application services are described in the following subsections.

3.2.1 DATA FORMATS

This section defines the set of types that will be used for payload health and status data, safety data, and payload generated ancillary data. The valid data types are described below.

3.2.1.1 OCTET

An octet is eight bits numbered as described in section 3.1.1, Notations.

3.2.1.2 SIGNED INTEGERS

Signed integers will have their sign determined by Bit 0 as described in section 3.1.1, Notations. Signed integers may have two lengths: 16 and 32 bits.

3.2.1.3 UNSIGNED INTEGERS

Unsigned integers are N-bit fields numbered as described in section 3.1.1, Notations. Unsigned integers may have two lengths: 16 and 32 bits.

3.2.1.4 FLOATING POINT

Floating point parameters will adhere to IEEE 754 format for single and double precision.

3.2.1.5 ENUMERATION TYPE

An enumeration type will be defined as an ordered set of distinct enumeration literals. Each enumeration literal is identified by its position in the declaration. Enumerated types will start at 0. Enumeration literals are stored as distinct integer codes which satisfy the predefined ordering of the type, as if the enumeration type were a signed integer of the same length, using the bit numbering described in section 3.1.1, Notations. Enumeration types may have three lengths: 8, 16 and 32 bits.

3.2.1.6 BOOLEAN TYPE

Variables of the Boolean type:

- 1) 'true' shall{3.2.1.6-A} have the value of '1'
- 2) 'false' shall{3.2.1.6-B} have the value of '0'

3.2.1.7 CHARACTER TYPE

Character type will be an eight bit field with a range of 0 to 255. There are two sub-character types: 1) The basic ASCII type with the numeric range 0 to 127; 2) The user character type with a numeric range 128 to 255 for user defined coding scheme.

3.2.1.8 BITSET

The bitset type is 32 bits containing specific bit patterns. It is null derived from a 32 bit unsigned integer.

3.2.1.9 DURATION

Reserved

3.2.1.10 STRINGS

There will be two character types: 1) A string type character; and 2) A string type octet. The string type comprises a length delimiting field followed by a sequence of characters or octets. The length delimiter will be a 16 bit unsigned integer identifying the number of characters or octets that follow.

3.2.2 TIME CODES

This section describes the formats for CCSDS unsegmented and segmented time codes.

Payloads sending Time Codes shall{3.2.2-A} be as defined in CCSDS 301.0-B-2.

3.2.2.1 SEGMENTED TIME CODES

Segmented time codes will be Broadcast Time as defined in section 3.3.2.2.2 of SSP 41175-2.

3.2.2.2 UNSEGMENTED TIME CODES

Unsegmented time codes will be as defined in Table 3.3.2.1.1-2 of SSP 41175-2.

3.2.3 LAYER 2 PROTOCOL

This section identifies the MIL-STD-1553B protocol implementation used by payloads to communicate as a Remote Terminal (RT) with the MIL-STD-1553B Controller (Payload MDM).

3.2.3.1 GENERAL

The protocol implementation for the Payload MDM MIL-STD-1553B local buses conforms to applicable document MIL-STD-1553B. The MIL-STD-1553B Bus Controller (BC) always initiates the information transfers on the MIL-STD-1553B. There can only be one BC on a MIL-STD-1553B at any one time. All other terminals on the MIL-STD-1553B will operate as RTs. The BC is located in the Payload MDM. The MIL-STD-1553B protocol is composed of the Command Words (CW), Status Words (SW), and Data Words (DW). From these three word types, 8 message formats are composed as stated in MIL-STD-1553B.

Payload MDM local bus has unique 100 millisecond processing frame profiles which are shown for informational purposes in Appendix A of this document. Timing requirements related to those bus profiles are contained in section 3.2.3.5, section 3.2.3.9.1, and section 3.2.3.10 of this document. Other information regarding processing frames and synchronization may be found in section 3.3.2.1.2, section 3.3.2.2.1, and section 3.3.2.2.2 of SSP 41175-2.

Payload MDM local bus address assignments for ISPR RTs are in accordance with Table 3.3.4.3.4-1 of SSP 41002, International Standard Payload Rack to NASA/ESA/NASDA Modules Interface Control Document. The complete payload bus address assignment list is in accordance with section 3.2, Bus Address Assignments of SSP 50193-1, Software ICD Part 1, Payload Multiplexer/Demultiplexer to ISS, Book 1, Hardware Architecture.

For CCSDS data transfers between the BC and RT, the CCSDS Packet Transfer Mechanism protocol is a layer above the standard MIL-STD-1553B protocol. RT to RT transfers are not supported on the 1553 Payload MDM local buses.

3.2.3.2 WORD INTERFACE

The following sections define the content and format of the MIL-STD-1553B Command, Status, and Data Word Interfaces.

3.2.3.2.1 COMMAND WORD INTERFACE

The command word shall{3.2.3.2.1-A} be as defined in MIL-STD-1553B, 4.3.3.5.1.

3.2.3.2.1.1 SYNC

The sync field in the command word shall{3.2.3.2.1.1-A} be as defined in MIL-STD-1553B, 4.3.3.5.1.1.

3.2.3.2.1.2 REMOTE TERMINAL ADDRESS

The remote terminal address shall{3.2.3.2.1.2-A} be as defined in MIL-STD-1553B, 4.3.3.5.1.2.

3.2.3.2.1.3 TRANSMIT/RECEIVE BIT

The Transmit/Receive (T/R) bit shall{3.2.3.2.1.3-A} be as defined in MIL-STD-1553B, 4.3.3.5.1.3.

3.2.3.2.1.4 SUBADDRESS/MODE (SAM) FIELD

For a list of the Subaddress (SA) Numbers that are currently defined, see Table 3.2.3.2.1.4-1 Subaddress Assignments.

TABLE 3.2.3.2.1.4-1 SUBADDRESS ASSIGNMENTS

SA#	Transmit (T/R=1)	Receive (T/R=0)
0	Mode Code (SAM=00000) Command	Mode Code Command
1	Reserved	Reserved
2	Reserved	Reserved
3	Reserved	Reserved
4	Reserved	Reserved
5	Reserved	Reserved
6	Reserved	Reserved
7	Reserved	Ancillary Data
8	Low Rate Telemetry Data	Command, Request Response (1)
9	Health and Status Data	Command, Request Response (2)
10	Reserved	Reserved
11	Reserved	Reserved
12	Reserved	Reserved
13	Reserved	Broadcast Ancillary Data (1)
14	Reserved	Broadcast Ancillary Data (2)
15	Reserved	File Transfer
16	Reserved	File Transfer
17	File Transfer	File Transfer
18	File Transfer	File Transfer
19	File Transfer	File Transfer
20	File Transfer	File Transfer
21	File Transfer	File Transfer
22	File Transfer	File Transfer
23	File Transfer	File Transfer
24	File Transfer	Reserved
25	File Transfer	Reserved
26	Reserved	Reserved
27	Reserved	Reserved
28	Reserved	Reserved
29	Reserved	Broadcast Time
30	Reserved(Data Wrap Read)	Reserved(Data Wrap Write)
31	Mode Code (SAM=11111) Command	Mode Code Command

3.2.3.2.1.5 DATA WORD COUNT/MODE CODE

The contents of the data word count/mode code field shall{3.2.3.2.1.5–A} be as defined in MIL–STD–1553B, 4.3.3.5.1.5.

The standard MIL–STD–1553B mode codes are shown in Table 3.2.3.2.1.5–1, Mode Codes. BC and RT hardware shall{3.2.3.2.1.5–B} implement the mode codes which contain a “Yes” in the required column, as specified in the corresponding paragraphs which follow.

TABLE 3.2.3.2.1.5–1 MODE CODES

T/R	Mode Code	Function	Data Words	Required
1	00000	Dynamic Bus Control	No	No
1	00001	Synchronize (without data word)	No	No
1	00010	Transmit Status Word	No	Yes
1	00011	Initiate Self Test	No	Yes
1	00100	Transmitter Shutdown (SD)	No	Yes
1	00101	Override Transmitter (SD)	No	Yes
1	00110	Inhibit Terminal Flag	No	No
1	00111	Override Inhibit Terminal Flag	No	No
1	01000	Reset Remote Terminal	No	Yes
1	01001	Reserved	No	N/A
	to			
1	01111	Reserved	No	N/A
1	10000	Transmit Vector Word	Yes	Yes
0	10001	Synchronize (with data word)	Yes	Yes
1	10010	Transmit Last Command	Yes	Yes
1	10011	Transmit BIT Word	Yes	Yes
0	10100	Selected Transmitter SD	Yes	No
0	10101	Override Selected Transmitter SD	Yes	No
1/0	10110	Reserved	Yes	N/A
	to			
1/0	11111	Reserved	Yes	N/A

BIT = Built In Test

3.2.3.2.1.5.1 DYNAMIC BUS CONTROL

This mode code causes the RT to become the BC as described in paragraph 4.3.3.5.1.7.1 of MIL-STD-1553B. The Dynamic Bus Control is not implemented by the Payload MDM and is shown only for completeness.

3.2.3.2.1.5.2 SYNCHRONIZE (WITHOUT DATA WORDS)

This mode code causes the RT to Synchronize as defined in paragraph 4.3.3.5.1.7.2 of MIL-STD-1553B, . The Synchronize Without Data Words mode code is not implemented by the Payload MDM and is shown only for completeness.

3.2.3.2.1.5.3 TRANSMIT STATUS WORD

This mode code causes the transmitting of status word and shall{3.2.3.2.1.5.3-A} be as defined in MIL-STD-1553B, 4.3.3.5.1.7.3.

3.2.3.2.1.5.4 INITIATE SELF TEST

This mode code causes the RT to initiate the self test and shall{3.2.3.2.1.5.4-A} be as defined in MIL-STD-1553B, 4.3.3.5.1.7.4.

3.2.3.2.1.5.5 TRANSMITTER SHUTDOWN (SD)

This mode code causes the RT to disable the transmitter and shall{3.2.3.2.1.5.5-A} be as defined in MIL-STD-1553B, 4.3.3.5.1.7.5.

3.2.3.2.1.5.6 OVERRIDE TRANSMITTER SD

This mode code causes the RT to enable a transmitter which was previously disabled and shall{3.2.3.2.1.5.6-A} be as defined in MIL-STD-1553B, 4.3.3.5.1.7.6.

3.2.3.2.1.5.7 INHIBIT TERMINAL FLAG

This mode code causes the RT to set the Terminal Flag bit in the status word as defined in MIL-STD-1553B, 4.3.3.5.1.7.7. The Inhibit Terminal Flag is not implemented by the Payload MDM and is shown only for completeness.

3.2.3.2.1.5.8 OVERRIDE INHIBIT TERMINAL FLAG

This mode code causes the RT to override the Terminal Flag bit set in the Inhibit Terminal Flag command as defined in MIL-STD-1553B, 4.3.3.5.1.7.8. The Override Inhibit Terminal Flag is not implemented by the Payload MDM and is shown only for completeness.

3.2.3.2.1.5.9 RESET REMOTE TERMINAL

This mode code causes the RT to reset and shall{3.2.3.2.1.5.9-A} be as defined in MIL-STD-1553B, 4.3.3.5.1.7.9.

3.2.3.2.1.5.10 TRANSMIT VECTOR WORD

This mode code causes the RT to transmit a status word containing the service request information and shall{3.2.3.2.1.5.10-A} be as defined in MIL-STD-1553B, 4.3.3.5.1.7.11.

3.2.3.2.1.5.11 SYNCHRONIZE (WITH DATA WORD)

This mode code causes the RT to synchronize. The synchronization shall{3.2.3.2.1.5.11-A} be as defined in MIL-STD-1553B, 4.3.3.5.1.7.12. The Payload MDM will provide the Synchronize with Data Word message in the form of Broadcast Sync with Data per Section 3.3.2.2.1 of SSP 41175-2. The format of the data word contained in the Broadcast Sync with Data is given in Table 3.3.2.2.1-1 of SSP 41175-2.

3.2.3.2.1.5.12 TRANSMIT LAST COMMAND

This mode code causes the RT to transmit its status word and bits 4-19 of the last command word before the Transmit last command and shall{3.2.3.2.1.5.12-A} be as defined in MIL-STD-1553B, 4.3.3.5.1.7.13.

3.2.3.2.1.5.13 TRANSMIT BIT WORD

This mode code causes the RT to transmit its status word and shall{3.2.3.2.1.5.13-A} be as defined in MIL-STD-1553B, 4.3.3.5.1.7.14.

3.2.3.2.1.5.14 SELECTED TRANSMITTER SHUTDOWN

This mode code causes the RT to disable the transmitter associated with a specified redundant data bus. The command is designed for use with systems employing more than two redundant buses. The Selected Transmitter Shutdown command is not implemented by the Payload MDM and is shown only for completeness.

3.2.3.2.1.5.15 OVERRIDE SELECTED TRANSMITTER SHUTDOWN

This mode code causes the RT to enable a transmitter which was previously disabled. The command is designed for use with systems employing more than two redundant buses. The Override Selected Transmitter Shutdown command is not implemented by the Payload MDM and is shown only for completeness.

3.2.3.2.1.6 PARITY

The Parity Bit shall {3.2.3.2.1.6-A} be as defined in MIL-STD-1553B, 4.3.3.5.1.6.

3.2.3.2.2 STATUS WORD INTERFACE

The status word is used to communicate the condition of the RT to the MIL-STD-1553B controller as defined in MIL-STD-1553B, 4.3.3.5.3.

3.2.3.2.2.1 SYNC

The Sync field in the status word shall {3.2.3.2.2.1-A} be as defined in MIL-STD-1553B, 4.3.3.5.3.1.

3.2.3.2.2.2 REMOTE TERMINAL ADDRESS

The remote terminal address shall {3.2.3.2.2.2-A} be as defined in MIL-STD-1553B, 4.3.3.5.3.2.

3.2.3.2.2.3 MESSAGE ERROR BIT

The message error bit of the status word shall {3.2.3.2.2.3-A} be as defined in MIL-STD-1553B, 4.3.3.5.3.3.

3.2.3.2.2.4 INSTRUMENTATION BIT

The Instrumentation Bit of the status word is defined in paragraph 4.3.3.5.3.4 of MIL-STD-1553B. This function is not implemented by the Payload MDM and is shown only for completeness.

3.2.3.2.2.5 SERVICE REQUEST BIT

The Service Request Bit of the status word is described in paragraph 4.3.3.5.3.4 of MIL-STD-1553B. This function is not implemented by the Payload MDM and is shown only for completeness.

3.2.3.2.2.6 RESERVED

The reserved field shall{3.2.3.2.2.6-A} be as defined in MIL-STD-1553B, 4.3.3.5.3.6.

3.2.3.2.2.7 BROADCAST COMMAND RECEIVED BIT

The broadcast command received bit shall{3.2.3.2.2.7-A} be as defined in MIL-STD-1553B, 4.3.3.5.3.7.

3.2.3.2.2.8 SUBSYSTEM FLAG BIT

The Subsystem Flag Bit is defined in paragraph 4.3.3.5.3.9 of MIL-STD-1553B. This function is not implemented by the Payload MDM and is shown only for completeness.

3.2.3.2.2.9 MIL-STD-1553B BUSY BIT

The Busy Bit is defined in paragraph 4.3.3.5.3.8 of MIL-STD-1553B. The Payload MDM takes no system level action based on the busy bit.

3.2.3.2.2.10 DYNAMIC MIL-STD-1553B CONTROL ACCEPTANCE BIT

The Dynamic MIL-STD-1553B Control Acceptance Bit of the status word is described in paragraph 4.3.3.5.3.10 of MIL-STD-1553B. This function is not implemented by the Payload MDM and is shown only for completeness.

3.2.3.2.2.11 TERMINAL FLAG BIT

The terminal flag bit shall{3.2.3.2.2.11-A} be as defined in MIL-STD-1553B, 4.3.3.5.3.11.

3.2.3.2.2.12 PARITY

The parity bit of the status word shall{3.2.3.2.2.12-A} be as defined in MIL-STD-1553B, 4.3.3.5.3.12.

3.2.3.2.3 DATA WORD INTERFACE

Data words and data word format shall{3.2.3.2.3-A} be as defined in MIL-STD-1553B, 4.3.3.5.2.

3.2.3.2.3.1 SYNC

The sync field in the data word shall{3.2.3.2.3.1-A} be as defined in MIL-STD-1553B, 4.3.3.5.2.1.

3.2.3.2.3.2 DATA

The data field of the data word shall{3.2.3.2.3.2-A} be as defined in MIL-STD-1553B, 4.3.3.5.2.2.

3.2.3.2.3.3 PARITY

The parity bit of the data word shall{3.2.3.2.3.3-A} be as defined in MIL-STD-1553B, 4.3.3.5.2.3.

3.2.3.3 STANDARD MESSAGES

The legal message categories for the MIL-STD-1553B are defined in the sections below.

3.2.3.3.1 RECEIVE DATA MESSAGE (BC TO RT)

The Receive Data message is defined below, and Figure 3.2.3.3.1-1, Receive Data Message illustrates the basic mechanisms involved.

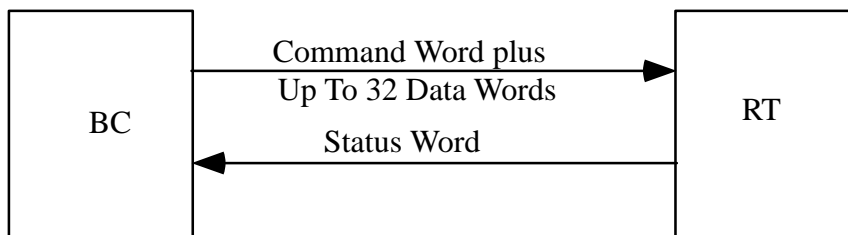

FIGURE 3.2.3.3.1-1 RECEIVE DATA MESSAGE

Table 3.2.3.3.1-1, Receive Data Message format describes the receive data message format. A Receive Data message shall{3.2.3.3.1-A} be as defined in MIL-STD-1553B, 4.3.3.6.1

TABLE 3.2.3.3.1-1 RECEIVE DATA MESSAGE

Source:	BC	Transfer Type:	BC->RT
Destination:	RT	Data Word Count:	1-32
Subaddress:	Receive Data	Transmit/Receive	R-SA# 1-30

Word #	Description	Function	Range	Position
CW	MIL-STD-1553B Command Word			
1	Data Word 1	Data from the BC	0-65535	0-15
2	Data Word 2	Data from the BC	0-65535	0-15
through	through			
32	Data Word 32	Data from the BC	0-65535	0-15
SW	MIL-STD-1553B Status Word			

3.2.3.3.2 TRANSMIT DATA MESSAGE (RT TO BC)

The Transmit Data message is defined below, and Figure 3.2.3.3.2-1, Transmit Data Message, illustrates the basic mechanisms involved.

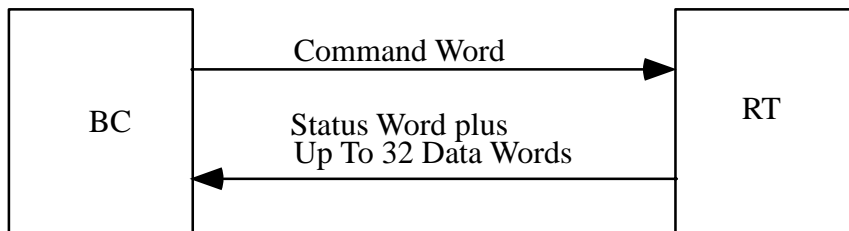

FIGURE 3.2.3.3.2-1 TRANSMIT DATA MESSAGE

Table 3.2.3.3.2-1, Transmit Data Message Format, describes the transmit data message format. A Transmit Data message shall{3.2.3.3.2-A} be as defined in MIL-STD-1553B, 4.3.3.6.2.

TABLE 3.2.3.3.2-1 TRANSMIT DATA MESSAGE FORMAT

Source:	RT	Transfer Type:	RT->BC
Destination:	BC	Data Word Count:	1-32
Subaddress:	Transmit Data	Transmit/Receive	T-SA# 1-30

Word #	Description	Function	Range	Position
CW	MIL-STD-1553B Command Word			
SW	MIL-STD-1553B Status Word			
1	Data Word 1	Data from the RT	0-65535	0-15
2	Data Word 2	Data from the RT	0-65535	0-15
through	through			
32	Data Word 32	Data from the RT	0-65535	0-15

3.2.3.4 COMMANDING

The US Lab provides commands to payloads from Ground, Timeliner, and the on-board Portable Computer System (PCS).

On each Payload MDM local bus, commands to the ISPR are transferred from the Payload MDM through two 32-word messages (i.e., a 64 word command packet) in each 100 millisecond processing frame through the two consecutive subaddresses shown in Table 3.2.3.2.1.4-1. This implies that an ISPR RT can receive up to ten commands in one second. For most commands, the data contained in the command message originates from or is routed through the Payload MDM and contains information meaningful only to the destination ISPR or subrack payload.

Each command packet will contain a CCSDS header as defined in section 3.3.2.1.1 of SSP 41175-02, and tailored per Appendix D of this document.

Command packets are transmitted from the Payload MDM in the format shown in Table 3.2.3.4-1, Command Packet Format. Command packets are always transmitted on the Payload MDM local buses as a 64 word Command Packet. The 64 word command packet has 11 words of overhead as described below:

- A. eight words of CCSDS header,
- B. one reserved word,
- C. one word of Legal Station Mode, and
- D. one word checksum.

The deductions from the CCSDS command packets noted above implies that only 53 words of the command packet may contain the actual command data.

Commands that are uplinked via S-Band have a minimum size of 24 words.

ISPRs for the ISS are not required to accept commands from the Orbiter Interface Unit (OIU).

The results of the processing of the payload command by PEP will be recorded in the PEP History Log data. The data will include a unique identifier for the command packet, the space station current time, and any error status.

TABLE 3.2.3.4-1 COMMAND PACKET FORMAT

Source:	BC	Transfer Type:	BC->RT
Destination:	RT	Data Word Count:	11-64
Subaddress:	Receive Data	Transmit/Receive	R-SA# 8,9
Message #1			
Word #	Description	Function	
CW	MIL-STD-1553B Command Word		
1	Data Word 1	CCSDS Primary Header	
through			
3	Data Word 3	CCSDS Primary Header	
4	Data Word 4	CCSDS Secondary Header	
through			
8	Data Word 8	CCSDS Secondary Header	
9	Reserved	Spare	
10	Reserved	Legal Station Mode	
11	Data Word 11	Command Data	
through			
32	Data Word 32	Command Data	
Message #2			
CW	MIL-STD-1553B Command Word		
1	Data Word 1	Command Data	
through			
32	Data Word 32	Command Data	

Note: The last word of the Command Packet is the checksum per the CCSDS packet. Since the Payload MDM always transmits commands as a 64-word packet, if the actual command length is less than 64 words then the data beyond the checksum should be considered “don’t care”.

3.2.3.4.1 PAYLOAD COMMANDING SERVICE CONSTRAINTS

Any command for routing by the PEP must have an APID identified by PEP in its configuration data.

3.2.3.4.2 PAYLOAD COMMANDING SERVICE ASSUMPTIONS

Assumptions upon which the Payload Commanding Service is based are as follows:

- A. It is assumed that any rack which has multiple payloads, such as an Expedite the Process of Experiments to Space Station (EXPRESS) rack, will have some form of central rack controller in the ISPR. The PEP only routes commands to the ISPR-level. Routing of the commands beyond the RT level is the responsibility of the rack controller per rack specified protocols.

3.2.3.5 HEALTH AND STATUS DATA

Health and Status (H&S) data is defined as: information originating at the payload/subrack payload and passed to the Payload MDM that provides the crew and ground confirmation of payload performance, operational state, resource consumption, and assurance that the payload is operating within safety guidelines as defined by the Payload Safety Review Panel and the ISS Flight Rules. Some examples of payload H&S data are subsystem status (power, voltages, currents, temperatures, pressures, fluid flow velocities, warning indicators, error messages/codes, etc.), digital communications systems statistics (1553, ethernet, and high rate system status, etc.), and video system status (camera and video recorder on/off indications, synchronization indicators, etc.).

A Subset Identifier (Subset ID) is assigned to each payload, subrack payload, payload support system, or other entity which is required to provide H&S data to the PEP via the 1553 Payload MDM local buses, or which expects to request PEP services via the Payload MDM local bus. This Subset ID will be unique to the entity to which it is assigned. It will be used by the Payload MDM for various reasons and will be used for decommutating the H&S data on the ground.

The format for the H&S data provided by an RT with a single Subset ID shall{3.2.3.5–A} be as given in Figure 3.2.3.5–1, Single Subset ID Health and Status Format. Once the H&S data has been provided to the Payload MDM by the Subset ID via the RTs H&S data, the data is then available for access by the Limit Checking Service, Timeliner, PCS Interface, Ancillary Data Services, etc.

The format for the H&S data provided by an ISPR containing multiple Subset IDs shall{3.2.3.5–B} be as given in Figure 3.2.3.5–2, Integrated ISPR Health and Status Format.

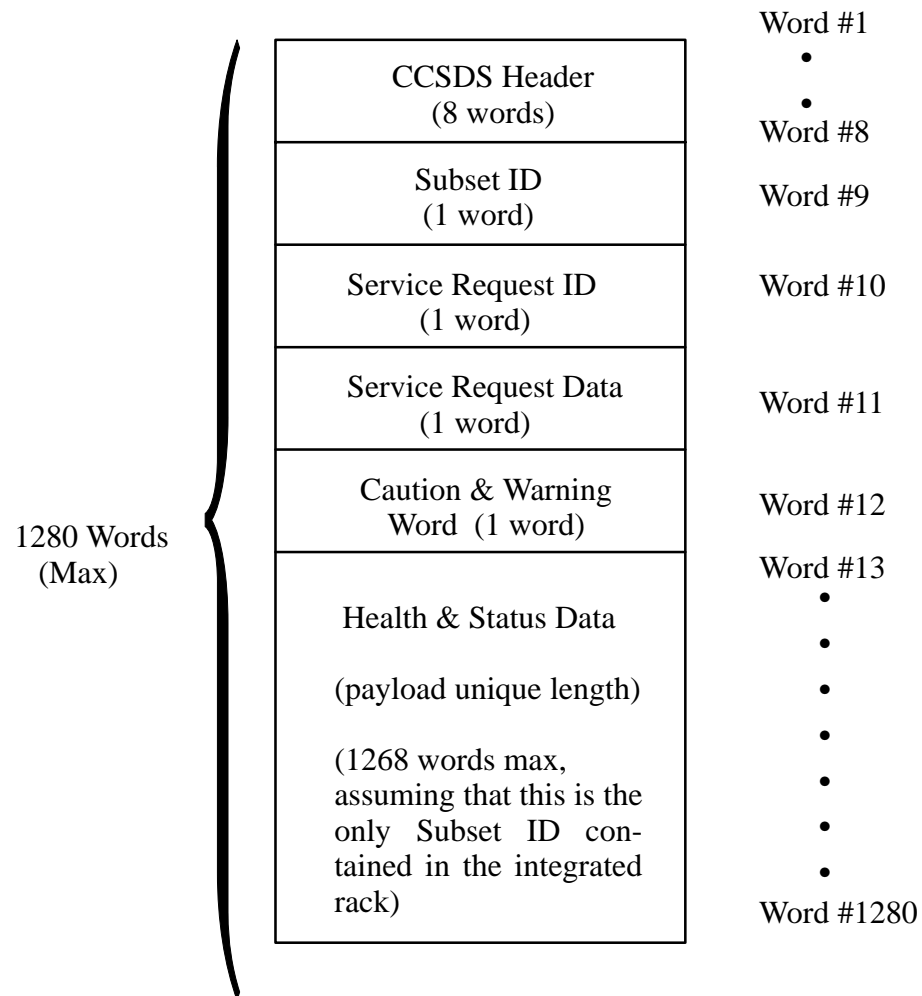

FIGURE 3.2.3.5-1 SINGLE SUBSET ID HEALTH AND STATUS FORMAT

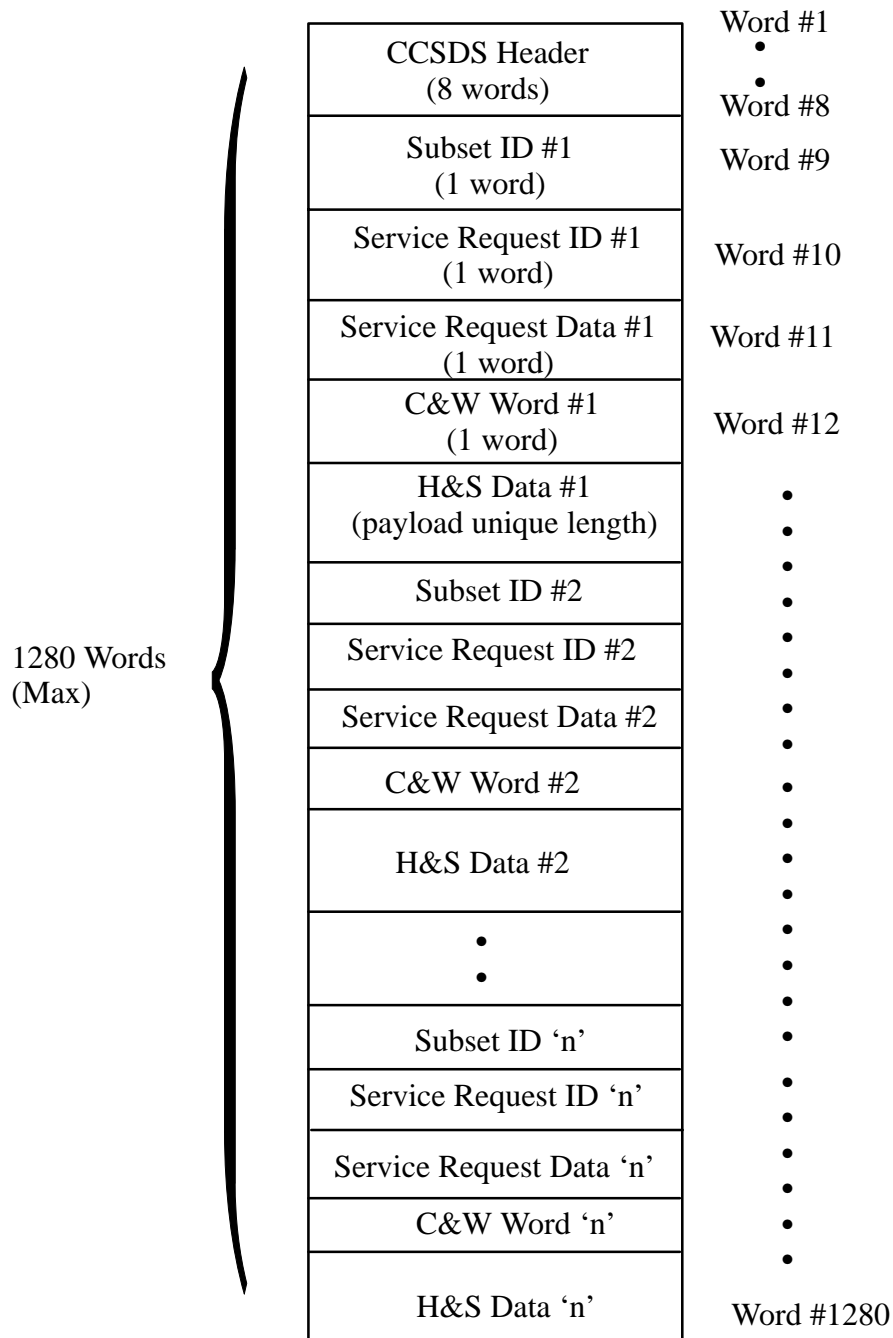

FIGURE 3.2.3.5-2 ISPR HEALTH AND STATUS FORMAT

Each H&S data package provided to the Payload MDM by an ISPR RT contains a CCSDS Header as specified in section 3.3.2.1.1 of SSP 41175-2. The CCSDS header is placed in the first eight words of the H&S data provided by an RT as shown in Figure 3.2.3.5-1, Figure 3.2.3.5-2, and Table 3.2.3.5-1.

The Payload MDM shall{3.2.3.5-C} collect the H&S CCSDS packages from the RTs at a predefined rate of 1.0 Hz or 0.1 Hz. The data rate at which the H&S data is collected will be determined by the PD/PI in conjunction with the Payload Safety Review Panel (PSRP), and their own analysis and associated safety reviews.

The Payload MDM shall{3.2.3.5-D} collect up to 1280 words of H&S data from each ISPR RT location. The 1280 words will include the CCSDS header.

The Payload MDM shall{3.2.3.5-E} collect H&S Data from ISPR RTs as four 32-word messages in the first 100 millisecond processing frame of the 1 second minor frame collection cycle. During subsequent 100 millisecond processing frames of the 1 second minor frame, the Payload MDM shall{3.2.3.5-F} collect up to four 32 word messages, but only enough 32 word messages to complete the collection of the H&S data. The exact number of transactions beyond the first 100 milliseconds will depend on the length of the packet as defined in Word #3 of the CCSDS primary header. Therefore, a maximum transfer of H&S data coming from an ISPR RT consists of 10 transactions within one second, each being four 32 word messages.

The H&S data is collected from the RTs at a single subaddress as shown in Table 3.2.3.2.1.4-1, Subaddress Assignments.

The Payload MDM shall{3.2.3.5-G} collect H&S data during the first half of the 100 millisecond processing frames as shown in Appendix A. ISPR RTs shall{3.2.3.5-H} update H&S data such that the data is ready to be read at the appropriate time within the 100 millisecond processing frame as the 32 word messages are requested. This requirement allows freedom of design such that the ISPR RT may update the H&S data whenever it chooses, as long as the data is ready when requested from the PLMDM. The RT can accomplish this by updating the H&S data during the last half of a 100 millisecond processing frame (see example of Health & Status update shown in Figure 3.2.3.5-3), by updating upon buffer read interrupts (if this can be accomplished fast enough between 32 word transfers), or by chaining the data buffers together using an auto-indexing technique.

Request Data embedded in the H&S data provided by a Subset ID shall{3.2.3.5-I} only be set for a single collection cycle for each request. The format for the Request Data shall{3.2.3.5-J} be as given in Figure 3.2.3.7-1, Service Requests.

The Caution & Warning (C&W) word embedded in each Subset ID's H&S data is provided so that the rack controller or the PEP can monitor for out-of-bounds safety related conditions. Availability of the C&W word to the PEP and the ISS C&W system will facilitate the isolation of problems or malfunctions to the subrack level for racks which have multiple payloads.

Payloads or subrack payloads which the PSRP have determined cannot cause such a condition shall{3.2.3.5-K} zero fill the C&W word. Payloads or subrack payloads which are required to report such a condition shall{3.2.3.5-L} set their summary C&W word to the following values:

0	—	No Problem
1	—	Advisory
2	—	Caution
3	—	Warning
4	—	Emergency(Toxic)
5	—	Emergency(Fire)
6	—	Emergency(Depress)

Subset IDs which have multiple C&W events occurring simultaneously shall{3.2.3.5-M} set their C&W word to the value representing the most severe event occurring at that time.

The C&W word shall{3.2.3.5-N} be placed as word #4 of H&S data for each Subset ID as shown in Figure 3.2.3.5-1 and Figure 3.2.3.5-2.

As the PEP collects H&S for each active Subset ID, a record is maintained of the Subset IDs for which H&S data was collected. After the data for all Subset IDs has been processed, a check is performed to determine if any Subset IDs requiring H&S data collection did not provide data. If a Subset ID fails to provide H&S data, then the event is recorded in the PEP History Log.

TABLE 3.2.3.5-1 HEALTH AND STATUS PACKET FORMAT

Source:	RT	Transfer Type:	RT->BC
Destination:	BC	Data Word Count:	11-1280
Subaddress:	Transmit Data	Transmit/Receive	T-SA# 9

Message #1		
Word#	Description	Function
CW	MIL-STD-1553B Command Word	
1	Data Word 1	CCSDS Primary Header
through		
3	Data Word 3	CCSDS Primary Header
4	Data Word 4	CCSDS Secondary Header
through		
8	Data Word 8	CCSDS Secondary Header
The following words and Messages contain the Health and Status Data of one or more Subset IDs contained within an ISPR. Note: As a minimum, the H&S packet format will contain a single Subset ID with Request Data words and a C&W Summary Word as shown in Figure 3.2.3.5-1. The format for an RT to report H&S data for multiple Subset IDs is given in Figure 3.2.3.5-2.		
9	Data Word 9	Health and Status Data
through		
32	Data Word 32	Health and Status Data

Message #2		
Word#	Description	Function
CW	MIL-STD-1553B Command Word	
1	Data Word 1	Health and Status Data
through		
32	Data Word 32	Health and Status Data

Message #3 through 40		
Word#	Description	Function
CW	MIL-STD-1553B Command Word	
1	Data Word 1	Health and Status Data
through		
32	Data Word 32	Health and Status Data

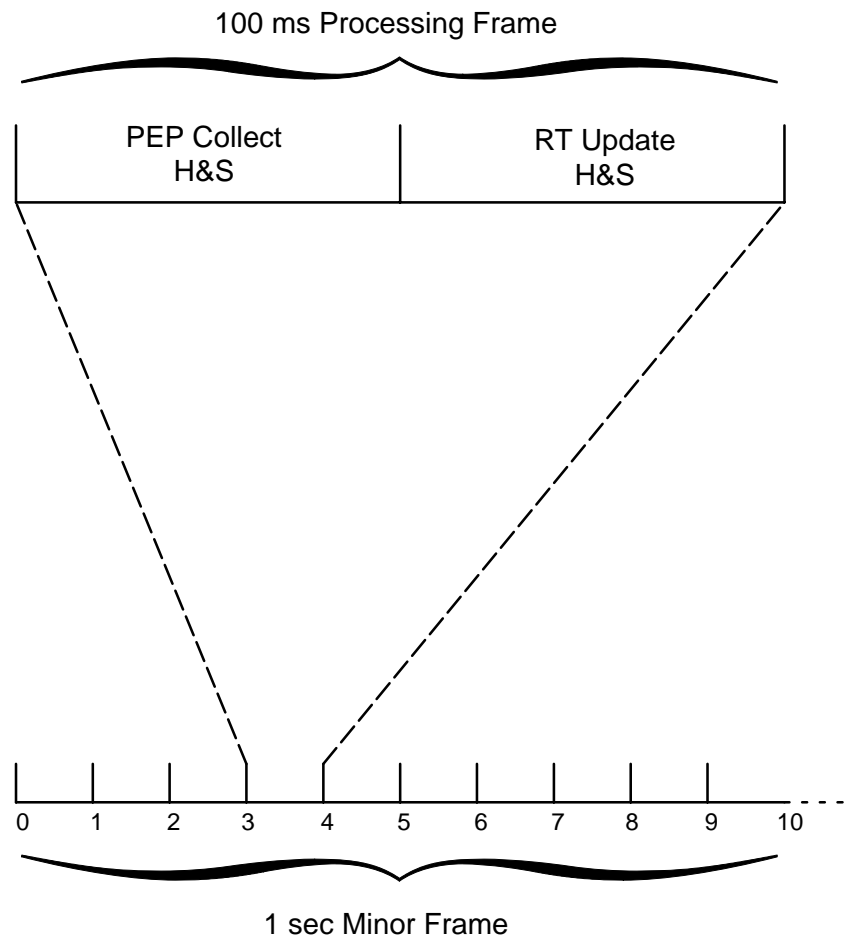

FIGURE 3.2.3.5–3 HEALTH AND STATUS UPDATE

3.2.3.5.1 LIMIT EXCEPTION SERVICE

The Limit Exception Service, in conjunction with the H&S Service, is for monitoring payload and payload support system data to detect out-of-limit conditions. Payload/Subset ID data to be monitored by the Limit Exception Service is provided to the PEP as part of a Subset ID’s H&S data. This service is activated every second to monitor data values stored in the PEP memory for possible limit exceptions.

The types of data which the PEP can monitor are specified below in section 3.2.3.5.1.1. Payloads/subrack payloads which require the use of the PEP Limit Exception Service shall{3.2.3.5.1–A} provide the parameter(s) to be monitored on 16 bit word boundaries in one of the formats listed in section 3.2.3.5.1.1.

The checks that can be performed against these data types shall{3.2.3.5.1–B} be:

- A. Upper Limit Exceeded,
- B. Lower Limit Exceeded,
- C. Equal To, and
- D. Not Equal To.

A Limit Exception Service response consists of initiating exception processing and providing notification to PCSs of the out-of-limit condition. Exception processing is predefined and may consist of either providing a command to execute an automated sequence, providing a command to a payload or payload support system, providing notification to PCSs via a message, and/or notifying the CCS MDM of a C&W event. Determining the Limit Exception Service response(s) that is(are) required is the responsibility of the PD/PI in conjunction with the PSRP and associated safety reviews.

PD/Pis who require the Limit Exception Service will enter those requirements as a part of the Command and Data Handling data packet via the SSP 57002 series ICDs. PD/Pis will also enter as a part of their requirements, a 'fault count value' for each data item to be monitored which specifies the number of consecutive faults that must occur before any action is taken. The fault count value shall{3.2.3.5.1-C} be in the range 1..60.

3.2.3.5.1.1 LIMIT CHECK SERVICE DATA TYPES

The PEP Limit Check Service shall{3.2.3.5.1.1-A} accommodate the following data types:

- A. Signed Integer (16 bits),
Range: -32768..32767
- B. Signed Long Integer (32 bits),
Range: -2,147,483,648..2,147,483,647
- C. Single Precision Floating Point (32 bits),
Range: (digits 6) $-(2.0-2.0^{**}(-23))*2.0^{**}127$..
 $(2.0-2.0^{**}(-23))*2.0^{**}127$
- D. Double Precision Floating Point (64 bits),
Range: (digits 15) $-(2.0-2.0^{**}(-51))*2.0^{**}1023$.. $(2.0-2.0^{**}(-51))*2.0^{**}1023$
- E. Boolean (16 bits)
Range: 2#0000000000000000#..2#0000000000000001#

3.2.3.5.1.2 LIMIT EXCEPTION SERVICE CONSTRAINTS

- A. The PEP Limit Exception Service can monitor up to 250 data items for out-of-limit conditions for a payload complement without reconfiguration of the Payload MDM.
- B. The Caution and Warning annunciation associated with the data item will be set for each sampling cycle (i.e., once per second) that the limit is exceeded, regardless if the exception has been handled previously or the consecutive fault count exceeded (i.e., the CCS will be notified each sampling cycle that the data value is out of limits).
- C. The data items to be monitored by the Limit Exception Service are enabled either by default when the PEP configuration data is loaded, or via a commanded data load.
- D. The data items to be monitored by the Limit Exception Service are disabled either by default when the PEP configuration data is loaded, via a commanded data load, or by PEP itself for any data items associated with a Subset ID for which the H&S collection service has been terminated
- E. The Fault Count associated with each data item is reset to zero each time the item being monitored goes back within bounds.

3.2.3.5.2 HEALTH AND STATUS SERVICE CONSTRAINTS

Specific constraints imposed upon the H&S Service are as follows.

- A. For multiple payload racks, the combined total of all H&S data for the Subset IDs present in that rack cannot exceed 1280 data words, inclusive of the CCSDS header.
- B. There is only one H&S data packet per Subset ID (i.e., the length of the H&S data can not change per subset ID without reconfiguration of the Payload MDM; the format of the H&S data may not change per Subset ID without reconfiguring the HOSC if processing of the data on the ground by the HOSC is required; the format of the H&S data can not change per Subset ID without reconfiguring the Payload MDM if processing of the data by the Payload MDM is required).

3.2.3.5.3 HEALTH AND STATUS SERVICE ASSUMPTIONS

Assumptions upon which the H&S Service is based are as follows.

- A. For multiple Subset IDs within a rack, there is a central rack controller which is responsible for collecting all active Subset ID H&S data, and for transmitting it upon command to the PEP (i.e., the PEP interface is to ISPR-level).

3.2.3.6 SAFETY DATA

Safety data is the set of payload generated C&W related parameters that are required to be available in the CCS MDM for S-band downlink, display to the crew on a core PCS, or monitored for C&W events. Determination of the safety-related parameters that are required is the responsibility of the PD/PI in conjunction with the PSRP and associated safety reviews. An example of safety-related data is a current or temperature sensor parameter which is being monitored for a situation that could lead to fire or overheating. Safety data shall{3.2.3.6-A} be included in the H&S data CCSDS packets provided by ISPR RTs.

3.2.3.7 SERVICE REQUESTS

Service Requests placed in a H&S data packet by a Subset ID shall {3.2.3.7-A} be located in the two words following the Subset ID for each reporting entity in the H&S data packet.

Valid Service Requests IDs shall {3.2.3.7-B} be as defined in Table 3.2.3.7-1, Service Requests.

TABLE 3.2.3.7-1 SERVICE REQUESTS

Service Request Type	Structure	Binary Definition
Low Rate Telemetry Start	1 Word (Request ID)	'00000000 00000011' B (or '3'D or '3'H)
	1 Word Number of Packets	Range {1-100}
Low Rate Telemetry Stop	1 Word (Request ID)	'00000000 00000100' B (or '4'D or '4'H)
Procedure Execution Start	1 Word (Request ID)	'00000000 00010010' B (or '18'D or '12'H)
	1 Word (Sequence ID)	Payload Dependent
Procedure Execution Stop	1 Word (Request ID)	'00000000 00010011' B (or '19'D or '13'H)
	1 Word (Sequence ID)	Payload Dependent
Procedure Execution Resume	1 Word (Request ID)	'00000000 00010100' B (or '20'D or '14'H)
	1 Word (Sequence ID)	Payload Dependent
Start File Read	1 Word (Request ID)	'00000000 00010000' B (or '16'D or '10'H)
	1 Word (File ID)	Payload Dependent
Start File Write	1 Word (Request ID)	'00000000 00010001' B (or '17'D or '11'H)
	1 Word (File ID)	Payload Dependent
Stop File Read	1 Word (Request ID)	'00000000 00011000' B (or '24'D or '18'H)
	1 Word (File ID)	Payload Dependent
Stop File Write	1 Word (Request ID)	'00000000 00011001' B (or '25'D or '19'H)
	1 Word (File ID)	Payload Dependent

Restart File Read	1 Word (Request ID)	'00000000 00011010' B (or '26'D or '1A'H)
	1 Word (Block #)	Payload Dependent
Ancillary Data Start	1 Word (Request ID)	'00000000 00000001' B (or '1'D or '1'H)
	1 byte (Data Set ID)	Data Set Dependent; Range {1–100}
	1 byte (Cyclic/Aperiodic)	'1'D (Cyclic) (See Note 1 below) '0'D (Aperiodic)
Ancillary Data Stop	1 Word (Request ID)	'00000000 00000010' B (or '2'D or '2'H)
	1 byte (Data Set ID)	Data Set Dependent (See Note 2 below)
Install Bundle	1 Word (Request ID)	'00000000 00010101' B (or '21'D or '15'H)
	1 Word (Bundle ID Parameter)	Payload Dependent
Halt Bundle	1 Word (Request ID)	'00000000 00010110' B (or '22'D or '16'H)
	1 Word (Bundle ID Parameter)	Payload Dependent
Remove Bundle	1 Word (Request ID)	'00000000 00010111' B (or '23'D or '17'H)
	1 Word (Bundle ID Parameter)	Payload Dependent
'null'	1 Word (No Request)	'00000000 00000000' B (or '0'D or '0'H)

NOTE 1: For 'Ancillary Data Start' request:

Most Significant Byte (Bits 0–7) contains the Rate (i.e., Cyclic vs. Aperiodic)

Least Significant Byte (Bits 8–15) contains the Data Set ID

NOTE 2: For 'Ancillary Data Stop' request:

Most Significant Byte (Bits 0–7) is not used

Least Significant Byte (Bits 8–15) contains the Data Set ID

The Payload MDM responds to PEP Service Requests with a Request Response packet. Request Response packets are normally only sent when a Service Request is denied. However, a positive response of “No Error” is provided for Timeliner–related Service Requests (i.e., Bundle/Procedure requests) that are error–free. The Request Response packet will be returned to the payload within 1–20 seconds depending upon how many other commands/Request Responses are already on the queue. The Request Response packets are 13 words in length and shall{3.2.3.7–C} be as shown in Table 3.2.3.7–2.

Data Word 9, Request ID, of the Request Response packet will contain the Service Request ID that was provided in the Health & Status data of the requesting Subset ID. Data Word 10, Request Data, will contain the Service Request Data that was provided as a parameter for the Service Request ID in the Health & Status data of the requesting Subset ID.

Data Word 11, Fault Code, of the Request Response Packet contains Fault Codes values as defined in Table 3.2.3.7–3, Payload Request Response Fault Code Values, that represent the response to PEP Service Requests.

Data Word 12, Request Response Data, is only used for Request Response packets related to the File Transfer Service as outlined in Sections 3.2.3.9.1 and 3.2.3.9.2.

TABLE 3.2.3.7–2 REQUEST RESPONSE PACKET FORMAT

Source:	BC	Transfer Type:	BC→RT
Destination:	RT	Data Word Count:	13 Note: 64 words will be xmitted
Subaddress:	Receive Data	Transmit/Receive	R–SA# 8, 9

Word #	Description	Function
CW	MIL–STD–1553B Command Word	
1	Data Word 1	CCSDS Primary Header
through		
3	Data Word 3	CCSDS Primary Header
4	Data Word 4	CCSDS Secondary Header
through		
8	Data Word 8	CCSDS Secondary Header (PL Subset ID)
9	Data Word 9	PL Request ID
10	Data Word 10	Request Data
11	Data Word 11	Fault Code
12	Data Word 12	Request Response Data
13	Data Word 13	Checksum

TABLE 3.2.3.7-3 PAYLOAD REQUEST RESPONSE FAULT CODE VALUES

Fault Code Name	Value	Meaning
No_Error	0	Possible response to Procedure Execution Start, Procedure Execution Stop, Procedure Execution Resume, Install Bundle, Halt Bundle, or Remove Bundle
Invalid_Anc_Data_Set_Requested	1	Possible response to Ancillary Data Start request.
Undefined_Anc_Data_Set_Requested	2	Possible response to Ancillary Data Start request
Req_Anc_Data_Already_Being_Provided	3	Possible response to Ancillary Data Start request
Req_Anc_Data_Is_Not_Being_Provided	4	Possible response to Ancillary Data Start request
Invalid_File_ID	15	Possible response to File Read or File Write request
PEP_Command_Buffer_Full	20	Possible response to any payload request
Queue_Full	21	Possible response to any payload request
Invalid_Payload_Request	23	Possible response to any payload request
Invalid_Payload_Index	24	Possible response to any payload request
LRT_Already_Being_Provided	27	Possible response to LRT Start request
LRT_Not_Being_Provided	28	Possible response to LRT Stop request
Invalid_LRT_Downlink_Rate	29	Possible response to LRT Start request
Invalid_Sequence_ID	30	Possible response to Procedure Start, Procedure Stop, or Procedure Resume request
Invalid_Bundle_ID	31	Possible response to Install Bundle, Halt bundle, or Remove Bundle request
Sequence_ID_Not_Found	32	Possible response to Procedure Start, Procedure Stop, or Procedure Resume request
Bundle_ID_Not_Found	33	Possible response to Install Bundle, Halt Bundle, or Remove Bundle request
Unauthorized_Sequence_Execution_Request	34	Possible response to Procedure Start, Procedure Stop, or Procedure Resume request
Unauthorized_Bundle_Execution_Request	35	Possible response to Install Bundle, Halt Bundle, or Bundle request
Timeliner_Cmd_Queue_Full	36	Possible response to Install Bundle, Halt Bundle, Remove Bundle, Procedure Start, Procedure Stop, or Procedure Resume request
Insufficient Bandwidth	38	Possible response to Start Low Rate Telemetry or Start Ancillary Data request
Device_Not_Available	42	Used by PEP but not by ISPRs.
Invalid_LRT_Packets	43	Possible response to a Start Low Rate Telemetry

Fault Code Name	Value	Meaning
Unauthorized File Request	76	Possible response to a Start File Read or a Start File Write.
File Transfer Completed	79	Possible response to a Start File Write.
Restart File Transfer	80	Possible response to a Start File Read or a Start File Write.
File Transfer Error	82	Possible response to a Start File Read or a Start File Write.

3.2.3.8 ANCILLARY DATA

Ancillary data is ISS systems or payload generated data that describes the environment in which a payload is operating. This data is made available to ISPR RTs in two formats: broadcast and unique sets.

3.2.3.8.1 BROADCAST ANCILLARY DATA

Broadcast Ancillary Data is sent at 10 Hz to all RTs as described in section 3.3.2.2.3 of SSP 41175–2. Two 32–word messages are broadcast during each 100 ms frame to each and every RT, to two consecutive subaddresses (#13 and #14) as shown in Table 3.2.3.2.1.4–1, Subaddress Assignments. Each 64–word transfer of Broadcast Ancillary Data contains a 10 Hz, 1 Hz, and 1/10 Hz data segment. The first eight words contain the CCSDS header and comprise the 10 Hz segment. The next 36 words comprise the 1 Hz segment, and the last 20 words comprise the 1/10 Hz segment. Transmission of the complete set of Broadcast Ancillary Data repeats every 10 seconds. Parameters contained in the 100 separately defined Broadcast Ancillary Data packets is contained in Appendix A of SSP 41175–2.

A Broadcast Frame Count in the range of 0..99 is contained as word #8 of the CCSDS header. RTs requiring access to Broadcast Ancillary Data should use the Broadcast Frame Count to decommutate the data. It should be noted that the Broadcast Frame Count contained in the Broadcast Ancillary Data and the Frame Count contained in Broadcast Sync with Data may have different values, and thus the reason for decommutating the Broadcast Ancillary Data based upon its own Broadcast Frame Count.

3.2.3.8.2 UNIQUE ANCILLARY DATA SETS

PD/Pis will identify their unique requirements for Ancillary Data as a part of their Command and Data Handling data sets in conjunction with the development of the SSP 57002 series ICDs. From these requirements, unique Ancillary Data Sets will be created, and each unique Ancillary Data Set will be assigned an Ancillary Data Set ID in the range of 1..100 by the PEP sustaining engineers or the Payload Utilization/Engineering and Integration function.

Once the sets have been grouped and an Ancillary Data Set ID has been assigned, the sets will be identified in the SSP 57002 series ICDs. At that point, the PD/Pis can identify the unique Ancillary Data Set(s) that their required data is contained in, and from that they will know which Ancillary Data Set ID(s) to use when sending an Ancillary Data Service Request to the PEP.

The PEP can be configured to support up to 100 unique Ancillary Data Sets without reconfiguration.

Unique Ancillary Data Sets will be predefined data groups with a predefined cyclic update rate of 1.0 Hz or 0.1 Hz. The unique Ancillary Data Sets will be transferred to an RT either

cyclically at the predefined update rate, or transferred once (“one-shot”) as specified in the PEP Service Request.

Each set will include eight words of CCSDS header, one word containing the Ancillary Data Set ID, and 23 data words as described in Table 3.2.3.8–1, Ancillary Data Packet Format. The RT must be capable of processing ancillary data whenever the data is received at the specified subaddress. No “handshaking” between the BC and the RT is required prior to the PEP sending ancillary data.

An Ancillary Data Set provided to an RT in response to a PEP Service Request is sent in one 32–word message to subaddress #7 as specified in Table 3.2.3.2.1.4–1. For each Payload MDM local bus, the Payload MDM supports 1–10 data sets for Ancillary Data at a 1 Hz rate, or 1–100 data sets for Ancillary Data at a 0.1 Hz rate, or a combination of the two which does not exceed 100 Ancillary Data packets within a 10 second period.

The Request ID associated with a PEP Service Request in a Subset ID’s H&S data will indicate that the request is either to start or stop the transmission of an Ancillary Data Set for that Subset ID. The parameters associated with the request identify the ancillary data set that is requested, and indicate whether the set is to be provided cyclically or aperiodically as a one-shot delivery.

If an Ancillary Data Request is received from a Subset ID, and if the requesting Subset ID is in a rack containing multiple payloads (e.g., an EXPRESS rack), then the RT (i.e., ISPR controller) is responsible for receiving and distributing the Ancillary Data Sets to the multiple Subset IDs within that rack per rack specified protocols.

When the Payload MDM provides an Ancillary Data Set to an RT, the Subset ID of the target entity for which the Ancillary Data Set is intended is contained in Word #8 of the CCSDS header.

If the PEP receives a valid request for an Ancillary Data Set, no response is provided to the requesting entity other than the transmission or termination of the requested set at the next processing cycle. When the PEP receives an invalid request, it will provide a Request Response with one of the fault codes shown in Table 3.2.3.7–3, Payload Request Response Fault Code Values. The Request Response will indicate the reason that the request was denied (e.g., Fault Code #3 would be returned to a Subset ID which requests to start an Ancillary Data Set that the PEP is already providing to it).

TABLE 3.2.3.8-1 ANCILLARY DATA PACKET FORMAT

Source:	BC	Transfer Type:	BC->RT
Destination:	RT	Data Word Count:	1-32
Subaddress:	Receive Data	Transmit/Receive	R-SA# 7

Word #	Description	Function
CW	MIL-STD-1553B Command Word	
1	Data Word 1	CCSDS Primary Header
through		
3	Data Word 3	CCSDS Primary Header
4	Data Word 4	CCSDS Secondary Header
through		
8	Data Word 8	CCSDS Secondary Header (contains the Subset ID of target payload or subrack payload that requested the set)
9	Data Word 9	Data Set ID
10	Data Word 10	Ancillary Data
through		
32	Data Word 32	Ancillary Data

3.2.3.9 FILE TRANSFER

Transfers of bulk file data between a payload RT and the PEP are initiated through the PEP Service Request mechanism. The mechanism for causing the PEP Service Request to be issued by the payload RT is determined by the developer of each ISPR. For example, the EXPRESS developers have defined a Rack Interface Controller (RIC) command that causes the RIC to request a PEP file transfer.

The File ID provided with a file service request is an unsigned 16-bit integer in the range of 0..65,535. The File ID is assigned by Payload Engineering Integration (PEI) office during the development of the payload-unique ICD per SSP 57002. When a file request and associated File ID are received by the PEP, through configuration data it will associate the File ID with a particular file name that was provided in the payload-unique ICD.

Transfers of bulk file data between PEP and a payload RT are limited to one per bus per direction at any one time. The implications of this are as follows:

- A. One RT can both transmit and receive file data during the same 100 millisecond processing frame, if no other RTs on the same Payload MDM local bus are using the PEP File Transfer Service.
- B. No two RTs can transfer file data to the PEP simultaneously on the same Payload MDM local bus.
- C. No two RTs can receive file data from the PEP simultaneously on the same Payload MDM local bus. The only exception to this occurs when a data load must be performed to a PCS on the same local bus, as explained in Section 3.2.3.9-2.
- D. The PEP can transfer file data to one RT and receive file data from another RT on the same Payload MDM local bus simultaneously.
- E. Access to the PEP File Transfer Service should be controlled by Payload Operations Personnel in cases where immediate access to the file is required.
- F. In cases where immediate access to the file is not required, developers of payloads/subrack payloads should develop their file transfer software to expect delays of reception and to handle delays in transmission of file data. Also, payload/subrack payloads may have to request the PEP File Transfer Service more than once before that service is granted.

Each file data packet shall{3.2.3.9-A} be structured as shown in Table 3.2.3.9-1, File Data Packet Format.

The transfer of file data in either direction (PEP to RT, or RT to PEP) requires a degree of handshaking between the source and destination to ensure completeness and accuracy. To achieve a complete and accurate data transfer, the file data will be passed in 256 word blocks that are enclosed in nine separate 32-word messages (288 words). Also included in the 288 words is CCSDS header information and checksum, the total file length in bytes, the number of words (of the 256 words) in the data field, and a Block Number.

The Block Number is a sequence number (starting at 1) that shall{3.2.3.9-B} be incremented by the sender of the file data for each 288-word packet transferred. The receiver of the data should use the block number to detect receipt of an out-of-sequence data transmittal and to initiate a restart of transmission from the missing block, or to ensure that the complete set of data is received and can be reassembled properly.

The transfer of file data is performed with a new block of nine 32-word messages every 100 milliseconds until the file transfer is complete. The nine messages are allocated to nine contiguous subaddresses as shown in Table 3.2.3.2.1.4-1, Subaddress Assignments.

The sender of file data packet(s) shall{3.2.3.9-C} prepare each packet as nine 32-word messages. Packets which do not require 288 words shall{3.2.3.9-D} be “don’t care” from the checksum to the end of the packet.

TABLE 3.2.3.9-1 FILE DATA PACKET FORMAT

Source:	BC	Transfer Type:	BC->RT / RT->BC
Destination:	RT	Data Word Count:	1-288
Subaddress:	Receive Data	Transmit/Receive	R/T-SA# 15-23/17-25

Message #1		
Word #	Description	Function
CW	MIL-STD-1553B Command Word	
1	Data Word 1	CCSDS Primary Header
through		
3	Data Word 3	CCSDS Primary Header
4	Data Word 4	CCSDS Secondary Header
through		
8	Data Word 8	CCSDS Secondary Header
9	Data Word 9	Not Used
through		
11	Data Word 11	Not Used
12	Data Word 12	Block number being transferred
13	Data Word 13	Not Used
14	Data Word 14	Length of file in bytes (MSW)
15	Data Word 15	Length of file in bytes (LSW)
16	Data Word 16	Number of words in data field
17	Data Word 17	File Data

through		
32	Data Word 32	File Data
Message #2 through #8		
CW	MIL-STD-1553B Command Word	
1	Data Word 1	File Data
through		
32	Data Word 32	File Data
Message #9		
CW	MIL-STD-1553B Command Word	
1	Data Word 1	File Data
through		
16	Data Word 16	File Data
17	Data Word 17	Checksum
18	Data Word 18	Not Used
through		
32	Data Word 32	Not Used

3.2.3.9.1 ISPR TO PEP FILE TRANSFER (PEP FILE WRITE)

The Payload MDM shall {3.2.3.9.1-A} collect file data during the last half of the 100ms processing frames as shown in Appendix A.

ISPR RTs shall {3.2.3.9.1-B} update file data such that the data is ready to be read at the appropriate time within the 100 millisecond processing frame as the messages are requested by the PEP. This requirement allows freedom of design such that the ISPR RT may update the file data whenever it chooses. The RT can accomplish this by updating the file data during the first half of a 100 millisecond processing frame (see example of file data update shown in Figure 3.2.3.9.1-1), or by any other method it chooses, as long as the data is ready when requested by the PEP.

For the bulk transfer of file data from the payload RT to the PEP, nine 32-word messages are transmitted to the PEP in each 100 ms processing frame. The messages are received by the PEP from nine consecutive message slots of the 128 possible, and the nine messages are allocated to subaddresses 17-25. The PEP must reconstruct the file data by concatenating each block in a sequential fashion. The process is repeated each 100 milliseconds until the last block is received. Once the entire file is transferred successfully, the PEP will issue a Request Response of Transfer Completed and close the file. This completes PEP processing of the file transfer transaction.

When the PEP detects a Start File Write service request, the following validation tests are performed:

- A. If the File ID passed as a parameter to the request is not found in the PEP configuration data, a Request Response of Invalid File ID is generated and the transaction is terminated.

- B. If the PEP configuration data does not indicate that the requesting entity is authorized to write to the target file, a Request Response of Unauthorized File Request is generated and the transaction is terminated.
- C. If a file write is already in progress for another RT on the bus that generated the PEP File Write, a Request Response of File Transfer In Progress is generated and the transaction is terminated.
- D. If the maximum number of supported file transfers is already in progress, a Request Response of Max Transactions In Progress is generated and the transaction is terminated.

If the request passes the validation tests listed in items 'A' through 'D' above, PEP will create and open the requested file for write (if it exists, it is first deleted).

Upon issuing the request for service, the RT will place the first block of nine 32-word messages into subaddresses 17–25 for transmission to the PEP. Word 12 of the first 32-word message contains the Block Number (1 for the first block), words 14 and 15 contain the file length (in bytes), while word 16 contains the number of data words in the current block. If the request is successful, no positive response is generated by the PEP, and the transfer of data is initiated automatically.

If a problem is detected in the middle of a file transfer with one of the blocks transferred to the PEP, the PEP will issue a Request Response of Restart Transfer, with word 12 of the message containing the Block Number at which to restart. The PEP will discard the file data subsequently received from the RT until the proper Block Number is received. Once the proper Block Number is received, the process will continue. PEP will terminate the file transfer if a response with the proper Block Number is not received within 10 seconds.

If a PEP storage problem is detected while the file transfer is in progress (e.g., HRDL MSD Write Error, HRDL MSD Error, FMT Timeout, HRDL Request Failure, etc.), a Request Response of File Transfer Error is issued. The transaction is then terminated.

At any time during the file transfer the RT can issue a Stop File Write request to terminate the transfer. PEP will immediately terminate the transaction but will provide no further Request Response(s) related to the transaction.

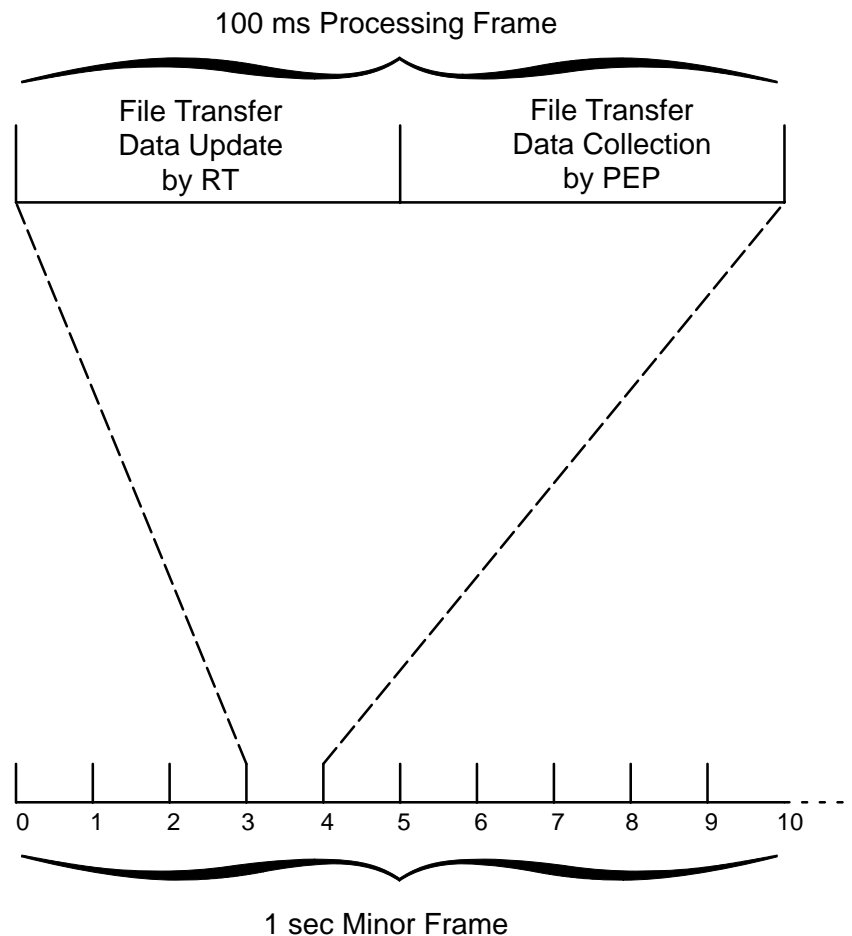

FIGURE 3.2.3.9.1-1 FILE TRANSFER DATA UPDATE

3.2.3.9.2 PEP TO ISPR FILE TRANSFER (PEP FILE READ)

The PEP file data transfer is performed with a new block of nine 32-word messages every 100 milliseconds until the file transfer is complete. The only exception to this 10 Hz rate occurs when a data load must be performed to a PCS on the same local bus (only during PCS initialization). In this case, the PCS data loads are multiplexed with the file transfer transmissions. The PCS data loads require two 100 millisecond processing frames, which implies that during PCS initialization, a payload RT receiving file transfer data may have a 200 millisecond delay between file transfer blocks.

Prior to issuing a request for a PEP File Read service, the ISPR should perform the necessary initialization to enable capturing 288 words per 100 milliseconds from the PL MDM local bus.

When the PEP detects a Start File Read service request, the following validation tests are performed:

- A. If the File ID passed as a parameter to the Start File Read request is not found in the PEP configuration data, a Request Response of Invalid File ID is generated and the transaction is terminated.
- B. If the PEP configuration data does not indicate that the requesting entity is authorized to read from the target file, a Request Response of Unauthorized File Request is generated and the transaction is terminated.
- C. If a file read is already in progress for another RT on the bus that generated the PEP File Read, a Request Response of File Transfer In Progress is generated and the transaction is terminated.
- D. If the maximum number of supported file transfers are already in progress, a Request Response of Max Transactions In Progress is generated and the transaction is terminated.

If the request passes the validation tests listed in items 'A' through 'D' above, the PEP will open the requested file to read. If the file is opened successfully, the PEP will place the first block of nine 32-word messages into subaddresses 15–23 for transmission to the payload RT. Word 12 of the first 32-word message contains the Block Number (1 for the first block), words 14 and 15 contain the file length (in bytes) while word 16 contains the number of data words in the current block. The data is then sent to the RT via nine consecutive receive messages.

The transfer of data is performed with a new block of nine 32-word messages every 100 milliseconds. Each block transferred will cause the PEP to increment the Block Number. The RT must reconstruct the file data by concatenating each block in as sequential fashion (after removing headers). PEP will continue to transmit the last block of file data until the RT issues a Stop File Read service request or until the transfer timeout value is exceeded (the Stop File Read service request must be received by the PEP within 10 seconds after the last block of data is received). Once the Stop File Read is received, PEP processing of the transaction is complete. If a timeout occurs before receipt of a Stop File Read service request, PEP will issue a FMT Timeout request response and terminate the transfer. PEP will then close the file.

If a PEP MSD problem is detected while the file transfer is in progress (e.g., HRDL MSD Write Error, HRDL MSD Error, FMT Timeout, HRDL Request Failure, etc.), PEP will issue a Request Response of File Transfer Error. PEP processing of the transaction is then terminated.

If the RT detects a fatal problem in the middle of a file transfer, a Stop File Read service request should be issued to the PEP to stop the file transfer. PEP will close the file and terminate the transaction but provide no further Request Response(s) related to the transaction.

If the RT detects a problem in the middle of a file transfer with one of the blocks, the RT should issue a Restart File Transfer service request to restart the file transfer, with word 12 indicating the Block Number at which to restart. The RT should discard the file data subsequently received from the PEP until the proper block number is received.

3.2.3.10 LOW RATE TELEMETRY

The Low Rate Telemetry (LRT) packets shall{3.2.3.10-A} be up to 640 data words in length as shown in Table 3.2.3.10-1. Each LRT packet contains a CCSDS Primary and Secondary Header. The CCSDS header identifies the appropriate ground facility as the destination, and identifies the total packet length.

The Payload MDM shall{3.2.3.10-B} acquire the data in twenty 32-word messages.

Each data transaction shall{3.2.3.10-C} be 20 messages regardless of CCSDS packet length.

The Payload MDM supports 100 LRT transactions per MIL-STD-1553B bus per 10 seconds. (i.e., on each Payload MDM local bus, the Payload MDM supports 1-10 transactions at a 1 Hz rate, or 1-100 transactions at a 0.1 Hz rate, or any combination of the two which does not exceed 100 LRT packets within a 10 second period). If the total amount of LRT requests received by the PEP for one local bus exceed 10 transactions per second, then the RT(s) that requests the LRT service that would force the PEP to exceed 10 transactions per second will be denied the service. That RT will receive a Request Response Packet with a Fault Code of '38'D indicating "Insufficient Bandwidth". For example, if Payload A requests 8 packets per second and the request is approved, and Payload B (on the same bus) subsequently requests 3 packets per second while the LRT service is being provided to Payload A, then Payload B would be denied the service.

Onboard access to PEP LRT Service is controlled by ground operators through configuration data tables within PEP. This configuration data is used by PEP during its validation of Subset ID LRT requests. That data specifies, for each Subset ID, one of the following three conditions: Not Authorized for LRT; Authorized for LRT at 1 Hz; Authorized for LRT at 0.1 Hz. The rate (i.e., 1.0 Hz or 0.1 Hz) at which a payload/subrack payload requires the LRT service and the number of packets required at that rate is captured via development of the payload-unique ICD per SSP 57002. The PEP will support LRT transactions by a payload/subrack payload at either a 1.0 Hz rate or a 0.1 Hz rate, but not both. If a payload/subrack payload is authorized LRT services, those services are requested via the Request Data contained in H&S data as shown in Figure NO TAG. Because the PEP LRT service is a bounded resource, access to those services will be controlled by negotiations between the Payload Operations function and the PD/PIs.

For PEP LRT Service, a mechanism similar to that used for H&S is employed by the PEP to collect twenty 32-word messages in each 100 millisecond processing frame from subaddress #8, as shown in Table 3.2.3.2.1.4-1. The messages are received by PEP into twenty consecutive message slots of the 128 possible during the processing frame. The slots in any given 100 millisecond processing frame are allocated to a single RT, but allocation across frames is left to the discretion of PEP, and is based upon previously received PEP Service Requests.

TABLE 3.2.3.10-1 LOW RATE TELEMETRY FORMAT

Source:	RT	Transfer Type:	RT->BC
Destination:	BC	Data Word Count:	1- 640
Subaddress:	Transmit Data	Transmit/Receive	T-SA# 8

Message #1		
Word #	Description	Function
CW	MIL-STD-1553B Command Word	
1	Data Word 1	CCSDS Primary Header
through		
3	Data Word 3	CCSDS Primary Header
4	Data Word 4	CCSDS Secondary Header
through		
8	Data Word 8	CCSDS Secondary Header
9	Data Word 9	Low-rate Telemetry Data
through		
32	Data Word 32	Low Rate Telemetry Data

Message #2 through 20		
Word #	Description	Function
CW	MIL-STD-1553B Command Word	
1	Data Word 1	Low-rate Telemetry Data
through		
32	Data Word 32	Low-rate Telemetry Data

As shown in Table 3.2.3.7-1, each Subset ID's LRT request contains a parameter identifying the number of LRT packets (twenty 32-word transactions) that are required. This number, along with the rate specified in the authorization data for the payload, is used by PEP to assign bus message slots for the LRT transmission. The LRT message slots assigned a given payload will remain allocated until that LRT service is terminated. The ten packets per second allocated to a Payload MDM local bus may be divided among the RTs/payloads/Subset IDs on that bus or may be assigned to a single RT/payload/Subset ID as determined by Payload Operations personnel.

The Payload MDM shall {3.2.3.10-D} collect LRT data during the last half of the 100ms processing frames as shown in Appendix A. ISPR RTs shall {3.2.3.10-E} update LRT such that the data is ready to be read at the appropriate time within the 100 millisecond processing frame as the messages are requested. This requirement allows freedom of design such that the ISPR RT may update the LRT data whenever it chooses. The RT can accomplish this by updating the LRT data during the first half of a 100 millisecond processing frame (see example of LRT data update shown in Figure 3.2.3.10-1), or by any other method it chooses, as long as the data is ready when requested by the PEP.

If the PEP receives a valid request for an LRT Service, no response is provided to the requesting entity other than the collection or termination of the requested set at the next processing cycle. When the PEP receives an invalid request, it will provide one of the Request Responses shown in Table 3.2.3.7-3. The Fault Code will indicate the reason that the request was denied (e.g.,

Fault Code #28 would be returned to a Subset ID which requests the termination of LRT services if PEP is not providing that service).

Once the RT sends the last packet of LRT data, it should send a Stop_Low_Rate_Telemetry request to the PEP. Because there is potential for the PEP to continue to collect LRT data for a few cycles after the RT has sent the request to terminate the service, the RT should continue to place an LRT packet at the subaddress with the CCSDS header indicating a Packet Length of '0' until the 1553 "handshaking" indicates that the PEP has ceased to collect the data. The Packet Length of '0' will indicate to the PEP that the data is to be discarded.

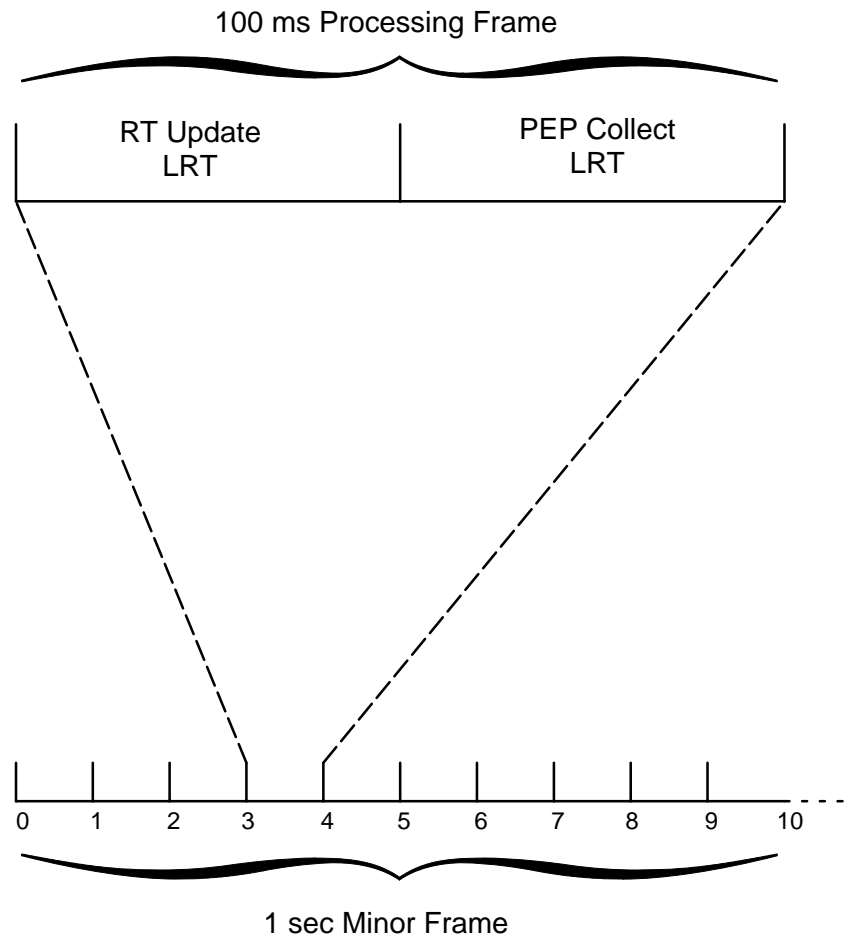

FIGURE 3.2.3.10-1 LOW RATE TELEMETRY DATA UPDATE

3.2.3.11 PROCEDURE EXECUTION SERVICE

This section is provided for informational purposes.

The Procedure Execution Service of the PEP allows automated control of payloads and processes via Timeliner procedures. The Procedure Execution Service capability is designed to meet the requirements to service requests from payloads/Subset IDs to control the execution of automated sequences. This capability, in conjunction with the Timeliner software, provides an on-orbit configurable capability to control payload operations based on command input or payload status feedback.

PD/PI will enter their requirements for automated Timeliner procedure execution as a part of their Command and Data Handling requirements data set in conjunction with the development of the SSP 57002 series ICDs. For each bundle and procedure to be initiated, the requirements must include an associated Bundle Name and Procedure Name. The Bundle Name and Procedure Name may be up to 32 characters in length. These entries are made at L-24 for International Standard Payload Rack (ISPR) facility class racks and at L-11 for EXPRESS rack payloads.

Once the PD/PI has entered the automated procedure requirements, Procedure IDs will be assigned to the procedures and Bundle IDs to the Timeliner bundles that they are contained in. Bundle IDs and Procedure IDs will be assigned as unsigned integers in the range 0...65535. Once the Bundle IDs and Procedure IDs have been assigned, the PD/PI will be provided access to them for use as needed. The PEP will support up to 500 total procedures and 50 total bundles without reconfiguration of the PEP. The procedures may all be used by one payload/Subset ID or – at the discretion of Payload Operations personnel – the procedures may be divided among payloads/Subset IDs.

In order for a Subset ID to successfully start a procedure, the bundle that it is contained in must first be Installed.

The Procedure Execution Service capability is activated when a Procedure Execution Request is received from a Subset ID via its H&S data, or when commanded by the crew or the ground. The request format for a Subset ID to request this service is as shown in Table 3.2.3.7-1, Service Requests. Commands for procedure execution which are generated by the crew (via PCS) or the ground will come to the PEP in the standard 64-word command format (which includes the CCSDS header) and are routed directly to the Timeliner software.

If the PEP receives a valid request for an Procedure Execution Service, a Request Response will be returned to the requesting entity with a Fault Code of '0', indicating No Error, per Table 3.2.3.7-3, Payload Request Response Fault Code Values. When the PEP receives an invalid request, it will provide one of the other Request Codes shown in that table as appropriate. The Fault Code will indicate the reason that the request was denied (e.g., Fault Code #32 would be

returned to a Subset ID which has requested to start a procedure/sequence when the associated Sequence ID is not recognized by PEP in its configuration data).

3.2.3.12 BROADCAST TIME

The Payload MDM shall{3.2.3.12-A} provide Broadcast Time at a 1 Hz rate, to subaddress 29, per Section 3.3.2.2.2 of SSP 41175-2.

3.3 MEDIUM RATE DATA LINK (MRDL)

The Medium Rate Data Link (MRDL) bus connects payloads to payloads and payloads to the ground through a gateway function. The MRDL is implemented on the ISS using twisted shielded pair cables configured in a hub and spoke topology, and operates at a data rate of 10 Mbps. The MRDL is implemented with the ISO/IEC 8802–3 Carrier Sensed Multiple Access with Collision Detection (CSMA/CD) 10 Base T. The Payload Ethernet Hub/Gateway (PEHG) provides a central hub or repeater mechanism for distributing incoming IEEE 802.3 packets. The ISO/IEC 8802–3 10 Base T commonly known as 10 Base T Ethernet.

3.3.1 MRDL CARRIER SENSED MULTIPLE ACCESS WITH COLLISION DETECTION (CSMA/CD) PROTOCOL

The physical media is a bus topology, i.e. all ‘stations’ hear what one station transmits. The physical implementation for ISS as a HUB. All ‘stations’ have two simplex shielded twisted pair cables running to the HUB. The HUB is the primary function of the Payload Ethernet Hub Gateway (PEHG). The maximum distance between the furthest MRDL stations is 100 meters.

The Carrier Sense Media Access is as follows:

A station that has data to transmit carrier senses, ‘listens’, to see if another ‘station’ is using the MRDL. If it is not in use, the ‘station’ immediately begins transmission. If it is in use then it waits for the Ethernet to become quiet, holds off for the Interframe gap and then begins transmission.

The Collision Detection is as follows:

If two or more stations waiting to transmit sense the media is available to use, both may wait the same Interframe gap and begin at the same time. If this happens a collision will occur. The collision is detected, 32 jam bits are sent which enforces the collision and notifies all ‘stations’ of the collision. The colliding stations then will retry using a “truncated binary exponential backoff” algorithm and slot time of 512 bits. If two stations keep offending each other then additional delays can be added to one station, i.e. lengthen the Interframe gap on one station.

Considerations in the design of the PEHG to implement the IEEE 802.3 10 Base T Protocol. The PEHG processing does not contribute more than 21 bit times (2.1 microsec) of delay in the delivery of any IEEE 802.3 packets. In the case where two or more PEHGs are connected together (JEM to US Lab) the PEHG only propagates each message one time.

3.3.2 ISPR MRDL CONNECTIVITY

ISPRs have two MRDL connections, one for each MRDL network in the Module. Each of the Module MRDL network is a separate collision domain which is not compromised by the ISPR.

The ISPR MRDL connections are not to become a physical or logical bridge between the two module collision domains. ISPRs can have the ability to use either MRDL for any type of communication.

ISPRs are not allowed to have their internal MRDL networks become a part of the Module MRDL networks. ISPRs with internal MRDL networks may use a gateway function to the Module MRDL networks which will provide the required isolation.

3.3.3 MRDL FRAME FORMAT

MRDL Frame Format is shown in Figure 3.3.3–1, MRDL Frame Format.

MRDL Header Format					User Data Field		
Preamble	SFD	Destination Address	Source Address	Length	LLC Data	PAD	Frame Check Sequence
7	1	6	6	2	Variable		4
(0) octet					(n) octet		

All field sizes are in Octets

Figure 3.3.3–1 MRDL Frame Format

3.3.3.1 TRANSMISSION ORDER

The octet of the MRDL frame, with the exception of the FCS, is transmitted low order bit first, b0 to b7. Octets are transmitted from 0 octet to the nth octet. The transmission order is shown in Figure 3.3.3.1–1, MRDL Transmission Order.

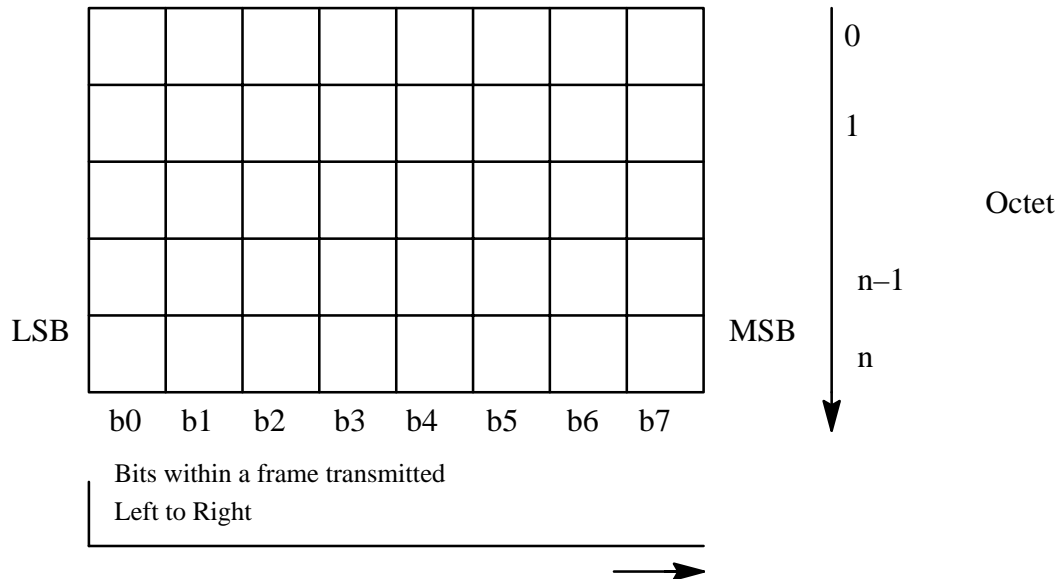

Figure 3.3.3.1–1 MRDL Transmission Order

3.3.3.2 PREAMBLE FIELD

The Preamble Field is a 7–octet field that is used to allow the physical layer circuitry to reach its steady–state synchronization with the received frame timing. The preamble pattern is:

10101010 10101010 10101010 10101010 10101010 10101010 10101010

3.3.3.3 START FRAME DELIMITER FIELD.

The Start Frame Delimiter (SFD) is the sequence immediately following the Preamble Field. The SFD sequence is 10101011.

3.3.3.4 ADDRESSES FIELDS

Each MRDL frame contains a Destination Address Field and a Source Address Field.

3.3.3.4.1 ADDRESS FIELD LENGTH

IEEE 802.3 supports both 16 bit and 48 bit length address fields as an implementation option. The ISS MRDL network uses only the 48 bit length address format. The 48 bit Address Format is shown in Figure 3.3.3.4.1–1, 48 bit Address Format.

Type	Administration	Address
1 bit	1 bit	46 Bits

Type = 0 Individual Address
 Type = 1 Group Address
 Administration = 0 Globally Administered Address
 Administration = 1 Locally Administered Address

Figure 3.3.3.4.1–1 48 Bit Address Format

3.3.3.4.2 ADDRESS TYPE

The first bit indicates the type Address. A ‘0’ B indicates the address field contains an individual address. A ‘1’ B indicates the address field contains a group address that identifies none, one or more, or all of the payloads connected to the MRDL.

The second bit is used for address administration information. This bit distinguishes between locally or globally (universally) administered addresses. A ‘0’ B indicates a globally administered address. A ‘1’ B indicates a locally administered address. This bit is also a ‘1’ B in the broadcast address.

The ISS uses globally administered address, see the section on address administration.

3.3.3.4.3 BROADCAST ADDRESS FIELD

The MRDL network address for a broadcast message is all ‘1’ Bs in the Destination Address Field.

3.3.3.4.4 DESTINATION ADDRESS FIELD

The Destination Address field specifies the MRDL ‘station’ for which the MRDL frame is intended. This may be another Payload or the PEHG Gateway address being used to down-link data from the ISS to the ground. The type field is used to indicate if the destination is an individual address or if the address is a group address. A payload transmitting a MRDL frames will use an individual address for the Destination.

3.3.3.4.5 SOURCE ADDRESS FIELD

The Source Address field specifies the “station” on the MRDL network. sending the MRDL frame. The type of the source address shall{3.3.3.4.5–A} be individual. The type bit is set to ‘0’ B. The source address is globally administered. The administration bit shall{3.3.3.4.5–B} be set to ‘0’ B. This address shall{3.3.3.4.5–C} either down-loadable via the MIL–STD–1553B, or permanently encoded into the MRDL “station”. Address assignments are described in the section 3.3.3.6 Address Administration .

3.3.3.5 FLOW CONTROL ADDRESS

The PEHG occasionally transmits a flow control message. The flow control message has a specific address, that may not be used by any “station” on the MRDL network. The flow control address is “00–02–7D–01–02–00” in Ring Hex Notation or “00–40–BE–80–40–00” in Bus Hex Notation.

3.3.3.6 ADDRESS ADMINISTRATION

ISS MRDL network addresses are given in Table 3.3.3.6–1.

TABLE 3.3.3.6–I ISS MRDL ‘Station’ Address

Address Assigned To:	Starting Address	Ending Address	# Address
Total Block Assigned to ISS	00 02 7D 01 02 00 Ring Hex Notation 00 40 BE 80 40 00 Bus Hex Notation	00 02 7D 01 41 FF Ring Hex Notation 00 40 BE 80 82 FF Bus Hex Notation	16384
ISS Flow Control Message	00 02 7D 01 02 00 Ring Hex Notation 00 40 BE 80 40 00 Bus Hex Notation	00 02 7D 01 02 00 Ring Hex Notation 00 40 BE 80 40 00 Bus Hex Notation	1
Reserved for ISS Vehicle Components	00 02 7D 01 02 01 Ring Hex Notation 00 40 BE 80 40 80 Bus Hex Notation	00 02 7D 01 03 FF Ring Hex Notation 00 40 BE 80 C0 FF Bus Hex Notation	511
Reserved for Internal Rack Gateways	00 02 7D 01 04 00 Ring Hex Notation 00 40 BE 80 20 00 Bus Hex Notation	00 02 7D 01 05 FF Ring Hex Notation 00 40 BE 80 A0 FF Bus Hex Notation	512
Reserved for ISS Payload Components	00 02 7D 01 06 00 Ring Hex Notation 00 40 BE 80 60 00 Bus Hex Notation	00 02 7D 01 41 FF Ring Hex Notation 00 40 BE 80 82 FF Bus Hex Notation	15360

Examples of the ISS Flow Control Address in the various IEEE 802.3 Notations.

- a. Binary Notation (by order transmitted on line, left to right):
0000 0000 0000 0010 0111 1101 0000 0001 0000 0010 0000 0000
- b. Ring Hex Notation (transmitted by octet left to right, high bit in each octet first):
00 02 7D 01 02 00
- c. Bus Hex Notation(transmitted by octet left to right, low bit in each octet first):
00 40 BE 80 40 00

3.3.3.7 LENGTH FIELD

The length field is a 2-octet field whose value indicates the number of LLC data octets in the data field. The length field is transmitted and received with the high order octet first. The field will range from 32 to 1500 bytes.

3.3.3.8 USER DATA FIELD

The user data field contains a sequence of octets. Full data transparency is provided in the sense that any arbitrary sequence of octet values may appear in the data field up to a maximum number specified by the implementation of this standard that is used.

3.3.3.9 PAD FIELD

The PAD is a field created by the IEEE 802.3 Station to provide the minimum frame size of 512 bits, that is required for correct CSMA/CD protocol operation. The PAD field size equals the greater of 0 bits or $(512 \text{ bits} - (8 \times (\text{Data field length in octets}) + 144(\text{Addresses} + \text{Length} + \text{Frame Check Sequence (FCS)})))$ bits.

3.3.3.10 FRAME CHECK SEQUENCE FIELD

A cyclic redundancy check (CRC) is used by the transmit and receive algorithms to generate a CRC value for the FCS field. The frame check sequence (FCS) field contains a 4-octet (32-bit) CRC value. This value is computed as a function of the contents of the source address, destination address, length, user data and pad (that is, all fields except the preamble, SFD, and FCS).

The Frame Check Sequence (FCS) field is a four octet (32-bit) cyclic redundancy checksum (CRC) calculated over the Address, Length, and Data Fields. It is used to detect errors in transmission.

3.3.4 GATEWAY PROTOCOL

The Payload Ethernet Hub/Gateway (PEHG) provides the gateway protocol. The gateway protocol provides the data packet transfer between user payloads, laptops and the Ku Band system through the HRDL. See Figure 3.3.4-1 MRDL to HRFM Gateway Flow.

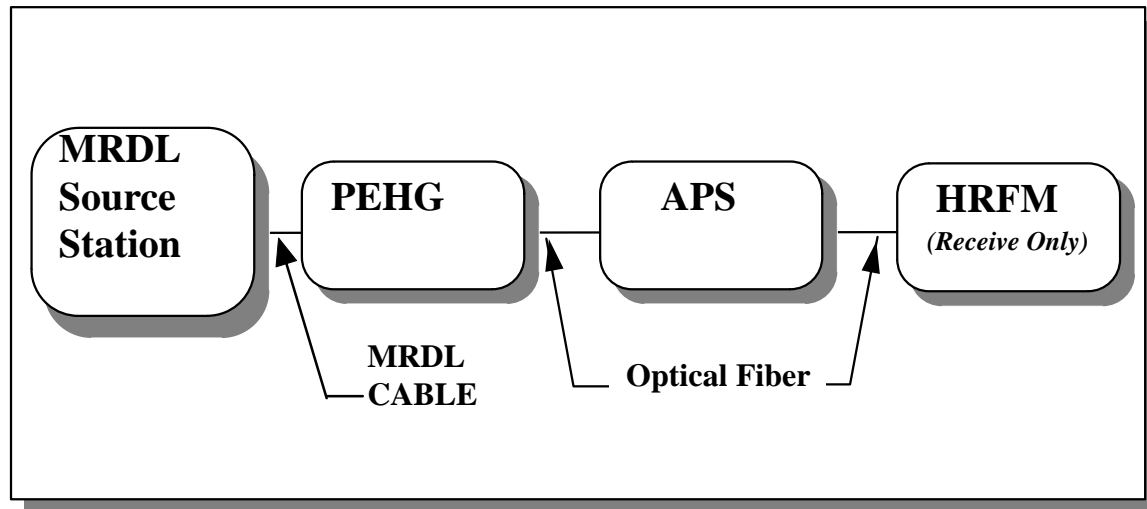

Figure 3.3.4–1 MRDL to HRFM Gateway Flow

The gateway function provides a simple forwarding capability for incoming MRDL frames with a specific destination address.

The gateway function checks the destination addresses of all incoming MRDL frames. The gateway function ignores packets with non-gateway MRDL destination addresses.

When a MRDL frame is addressed to the gateway function the following is performed:

- a. The gateway function removes the MRDL frame header and frame check sequence. No specific user data format or size is assumed, and the unwrapped user data will be referred to as user data.
- b. Each unwrapped user data, in the order received, is encoded in the HRDL format for transmission over the optical HRDL.

The gateway's output data is determined from a downloadable parameter, received from the Payload MDM via the Payload MDM MIL-STD-1553B. The output rate is adjustable from 0.5 Mbps to 10 Mbps in increments of 0.5 Mbps. This is the raw data rate and includes the CCSDS overhead. The true data rate is determined by extracting this overhead.

The gateway function provides 64 Kbytes of buffering for incoming user data. When an incoming MRDL frame encounters a buffer full condition, the gateway function discards the entire packet and increments the discarded packet counter by one. It will also transmit a buffer full message just before the condition occurs. See 3.3.4.1, Buffer Full Message

3.3.4.1 BUFFER FULL MESSAGE

The Source address of this message is the Gateway address, and the Destination address is the Source of the transmission that caused the overflow. The user data portion of this MRDL frame will consist of the first 6 bytes of the transmitted data field which is the CCSDS header information. This transmission can be enabled or disabled via the MIL-STD-1553B interface to the PEHG.

3.3.4.2 BUFFER FLOW CONTROL MESSAGE

A Buffer Overflow flow control message, consisting of 1500 bytes of alternating **01** (or 55 Hex) data, will be transmitted in entirety when a buffer full condition has occurred. This is to occupy the MRDL for a period of time to allow the buffer to forward user data to the HRDL. When the buffer full condition has been removed the gateway function will not send any further flow control message. The Source address of this message is the Gateway address, and the Destination address is 00 02 7D 01 02 00 Ring Hex Notation and in 00 40 BE 80 40 00 MIL-STD-1553B Hex Notation. No device will exist at this address, which prevents a response to the flow control message.

To assure the flow control gains access to the MRDL before another message from a MRDL 'station' transmits possibly to the gateway the PEHG uses a 9.6 microsecond inter-frame gap.

The number of gateway addressed packets between flow control messages is selectable from 1 to 16. This broadcast will be enabled or disabled via the MIL-STD-1553B interface.

This flow control message can provide simple network flow control by periodically blocking payloads' access to the media, thereby reducing the bursty payload(s) to gateway traffic (characteristic of a CSMA/CD environment) that may cause gateway buffer overflow.

3.3.4.3 INTERFRAME GAP

Interframe gap is the minimum time period from the last bit of the current MRDL frame and the first bit of the next MRDL frame. In the operation of the CSMA/CD a MRDL frame waiting to be transmitted, transmission is initiated immediately when the Interframe spacing has occurred. The minimum Interframe time takes into account the end to end propagation of the MRDL network. The Interframe gap for IEEE 802.3 10 Base T, is 9.6 microseconds.

3.4 HIGH RATE DATA LINK (HRDL)

High Rate Data Link is a simplex link composed of a source station and a receive station linked by a length of optical fiber and an Automated Payload Switch (APS) as shown in Figure 3.4-1, Typical High Rate Data Link.

The modes of operation discussed herein consists of: one, a Station-to-Station Mode that is used to describe and illustrate the minimum rules that must be followed in order to insure simplex communications in any mode, and; two HRFM Bit Stream and Frame Format Modes. Consequently, since all modes of operation may be considered subsets of the Station-to-Station Mode, developers are requested to read the paragraph herein that describes the Station-to-Station Mode.

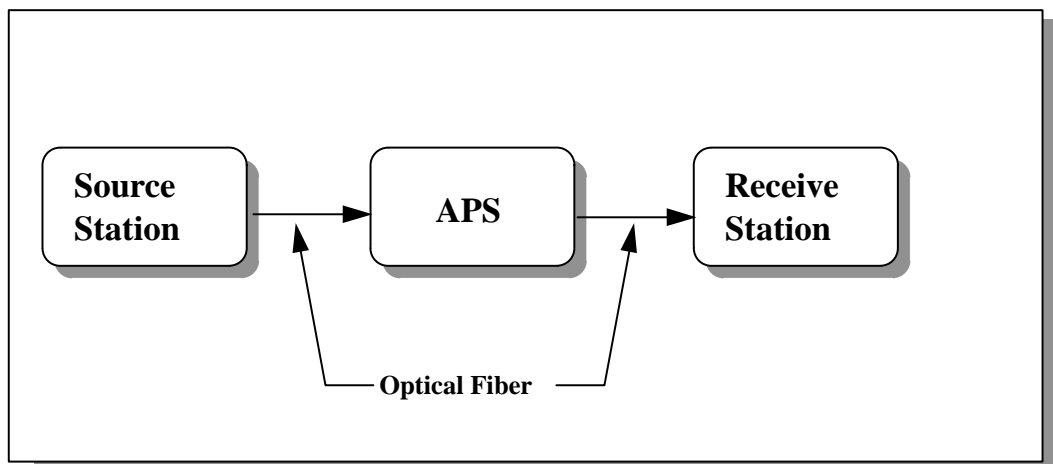

Figure 3.4–1 Typical High Rate Data Link

3.4.1 SIGNALING

The HRDL is Fiber Optic (FO) which transmits data as a light over a glass medium. The HRDL has a signaling (Baud) rate of 125 MHz. Non-Return to Zero Invert on Ones (NRZI) only changes from light to dark or dark to light when a '1' is transmitted. NRZI is used in the HRDL.

A system was devised to use a pattern of 5 bits to represent four bits (half of an octet), with the patterns selected in such a way that no matter which pattern follows another, the clocking and sync are maintained. The combinations of patterns include continuous repetitions. Out of the 32 bit combinations eight are not usable. This leaves 24 combinations with 16 representing the 0 through F Hexidecimal digits and 8 control codes. With this encoding, 4b/5b the data rate is 100 Mbps

3.4.1.1 DATA ENCODING

Data is presented on the HRDL with the following encoding as 4B/5B symbols representing the data symbols as shown in Table 3.4.1.1–1, Data Encoding.

TABLE 3.4.1.1–1 Data Encoding

Hex Data	Binary Data MSB–LSB	4B/5B Encoded Data MSB–LSB
0	0000	11110
1	0001	01001
2	0010	10100
3	0011	10101
4	0100	01010
5	0101	01011
6	0110	01110
7	0111	01111
8	1000	10010
9	1001	10011
A	1010	10110
B	1011	10111
C	1100	11010
D	1101	11011
E	1110	11100
F	1111	11101

Note: Symbols presented on link Most Significant Bit first

3.4.1.2 CONTROL SYMBOL

Control symbols presented on the HRDL is encoded as 4B/5B symbols as shown in Table 3.4.1.2–1. Control Symbols are presented as pair symbols. Control Symbols are the ordered pair of Delimiter Symbols described 3.4.1.2.2. Other Control Symbols and Line State Symbols described in the next section are not be used at anytime with HRDL signals being routed to the HRFM. These codes may be used in payload to payload communications on the HRDL.

TABLE 3.4.1.2-1 Control Symbols

Symbol	4B/5B Encoded Data MSB-LSB	Delimiter Pair	Notes
Sync	11000 10001	JK	
Start Delimiter	11001 00111	SR	
End Delimiter	00111 11001	RS	

Note: Symbols presented on link Most Significant Bit first

3.4.1.2.1 SYNC SYMBOL

The Sync symbols are used to: 1) Modulate data transfer rates and 2) Act as a signal to keep link receivers acquired when data is not presented on link. During a communications session, Sync symbols are to be present on the link whenever data, End Delimiters or Start Delimiters are not present.

3.4.1.2.2 START DELIMITER SYMBOLS

Start Delimiters, 'SR', are used to mark the beginning of a data frame and are not used for any other purpose.

3.4.1.2.3 END DELIMITER SYMBOLS

End Delimiters, 'RS', are used to mark the end of a data frame and are not used for any other purpose.

3.4.1.2.4 DELIMITER SYMBOLS AND LINE STATES

Delimiter Symbols and Line States are used by payloads as shown in the following Tables. The symbols represent legal symbols that are produced by any Physical Layer Complaint ANSI FDDI encoding and decoding devices. The Delimiters symbols shown in Table 3.4.1.2.2-1, Control Indicators and Table 3.4.1.2.2-2, Starting and Ending Delimiters with the exception of 'T' are used with the HRFM on the HRDL. The Line States shown in Table 3.4.1.2.2-3, Line States, while valid symbols are not used by the HRFM. Symbols T, Q, I and H may be used by payloads when the communication is between the payload racks of the same payload.

3.4.1.2.5 SYMBOLS USED IN TESTING

The Halt Symbol, see Line States, Table 3.4.1.2.2-3, is used to measure optical power of the the ORU and ISPRs. All other symbols are used in the evaluation of the fiber optic components at a component level. The primary function is the evaluation of bit error rate (BER).

TABLE 3.4.1.2.2–1 Control Indicators

Type Symbol	4B/5B Encoded Data MSB–LSB	Code	Notes
Sync	00111	R	Used with HRFM
Start Delimiter	11001	S	Used with HRFM

Note: Symbols presented on link Most Significant Bit first

TABLE 3.4.1.2.2–2 Starting and Ending Delimiters

Delimiter	4B/5B Encoded Data MSB–LSB	Code	Notes
Starting	11000	J	1st. of Sequential SD Pair
Starting	10001	K	2nd of Sequential SD Pair
Ending	01101	T	Used to Terminate the Data Stream– Not Used with HRFM

Note: Symbols presented on link Most Significant Bit first

TABLE 3.4.1.2.2–3 Line States

Line States	4B/5B Encoded Data MSB–LSB	Code	Notes
Quiet	00000	Q	1st. of Sequential SD Pair
IDLE	11111	I	2nd of Sequential SD Pair
HALT	00100	H	Used to Terminate the Data Stream

Note: Symbols presented on link Most Significant Bit first

3.4.1.3 INVALID SYMBOLS

These following code patterns violate consecutive code–bit zeros or duty cycle requirements and are not to be transmitted. Encoded symbols other than the data symbols and special symbols described herein are forbidden. Invalid Symbols are shown in Table 3.4.1.3–I Invalid Symbols.

TABLE 3.4.1.3–1 Invalid Symbols

4B/5B Encoded Data MSB–LSB	Code
00001	V or H
00010	V
00011	V
00101	V
00110	V
01000	V or H
01100	V
10000	V or H

Note: Symbols presented on link Most Significant Bit first

3.4.2 HRDL PROTOCOL REQUIREMENTS

3.4.2.1 STATION–TO–STATION MODE

The minimum required HRDL state diagram for the Station–to–Station Mode of operation is shown in Figure 3.4.2.1–1, HRDL Station–to–Station Mode State Diagram. The HRDL ORUs implement the following Station–to–Station Modes.

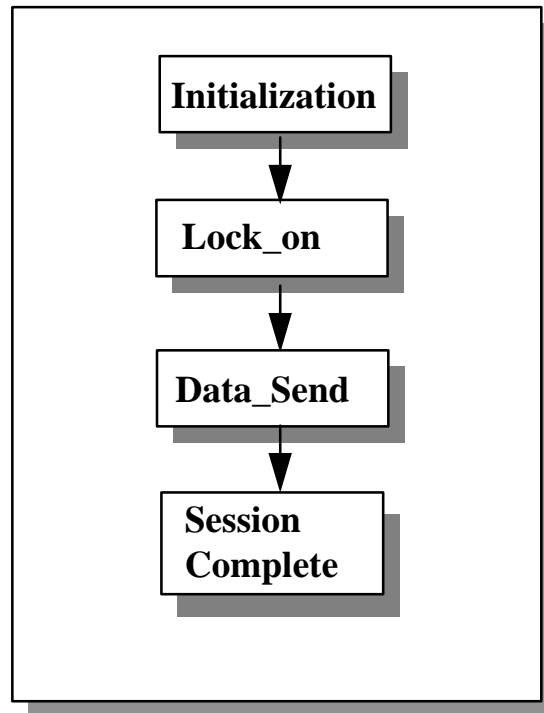

Figure 3.4.2.1-1 HRDL Station-to-Station Mode State Diagram

3.4.2.1.1 INITIALIZATION STATE

The Initialization state defines the actions which HRDL users must take prior to initiating Station-to-Station communications. As a minimum in this state, HRDL stations shall{3.4.2.1.1-A} provide the following capabilities as appropriate:

1. Apply power to the HRDL Transmitter/Receiver (Tx/Rx) circuitry in the APS, the receive station, and the transmit station by commands.
2. Establish station-to-station HRDL routing path through the APS via commands to the APS.
3. Establish station Tx and Rx data rates and data framing formats via commands to the transmit and receive stations.

The Initialization state shall{3.4.2.1.1-B} be considered complete when the transmit station, receive station, and the APS have been initialized, and a HRDL physical path between them has been established.

3.4.2.1.2 LOCK-ON STATE

In the Lock-On state, the transmit station shall{3.4.2.1.2-A} transmit symbols/data for a minimum of 100 microseconds over the HRDL network via the APS to the receive station in order to ensure that their receivers are locked. The Lock_On state is consistent with the Phase

Locked Loop (PLL) state, as described in the Transparent Asynchronous Transmitter–Receiver Interface (TAXI) vendor documentation.

The Lock–On state shall{3.4.2.1.2–B} be considered complete when the transmit station transmits symbols/data for a minimum of 100 microseconds to the APS and receive station over the HRDL. Also, a contiguous string of symbols shall{3.4.2.1.2–C} continue to be sent.

3.4.2.2 DATA_SEND STATE

HRDL stations shall{3.4.2.2–A} remain in this state while transmitting data packets according to the data transmission rules established herein. Data rates and data framing formats will be set prior to transmission. Data bytes may be interspersed with Sync symbols in order to modulate data rates.

The Data_Send state shall{3.4.2.2–B} be considered complete when the data transmission is complete. At this point, the transmit station, receive station, and the APS can terminate this HRDL transmission.

3.4.2.2.1 DATA RATE

HRDL stations shall{3.4.2.2.1–A} provide the capability to transmit and/or receive data at a maximum rate of 100 Mbps using the 4B/5B encoded scheme as defined in section 3.1.3. The data rate can be adjusted to data rates less than 100 Mbps using a technique of Evenly–Parsed data, as defined in section 3.3.1.3.2. The data rate shall{3.4.2.2.1–B} be adjustable in 0.5 Mbps increments. Since the signaling rate is fixed, the data rate is adjusted by inserting Sync Symbols.

3.4.2.2.2 EVENLY–PARSED DATA

Stations may evenly parse data onto the HRDL at the word level such that words presented on the HRDL network are separated by an equal number of Sync symbols. An example of evenly parsed data corresponding to a transmitted data rate of 20 Mbps is shown in Figure 3.4.2.2.2–1. In this example, four (4) Sync symbols are inserted between every 4B/5B encoded data bytes.

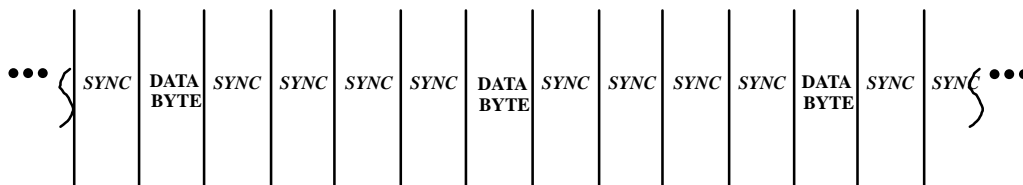

Figure 3.4.2.2-1 Example of Evenly-Parsed Data

3.4.2.3 HRFM MODES

HRDL stations which require a high rate telemetry downlink interface through the USOS Ku-Band system shall {3.4.2.3-A} operate in HRFM protocols. HRFM protocols consist of two rigidly defined protocols: a Bitstream protocol and a CCSDS Packet protocol. For reference, a typical transmit station-to-HRFM configuration is shown in Figure 3.4.2.3-1.

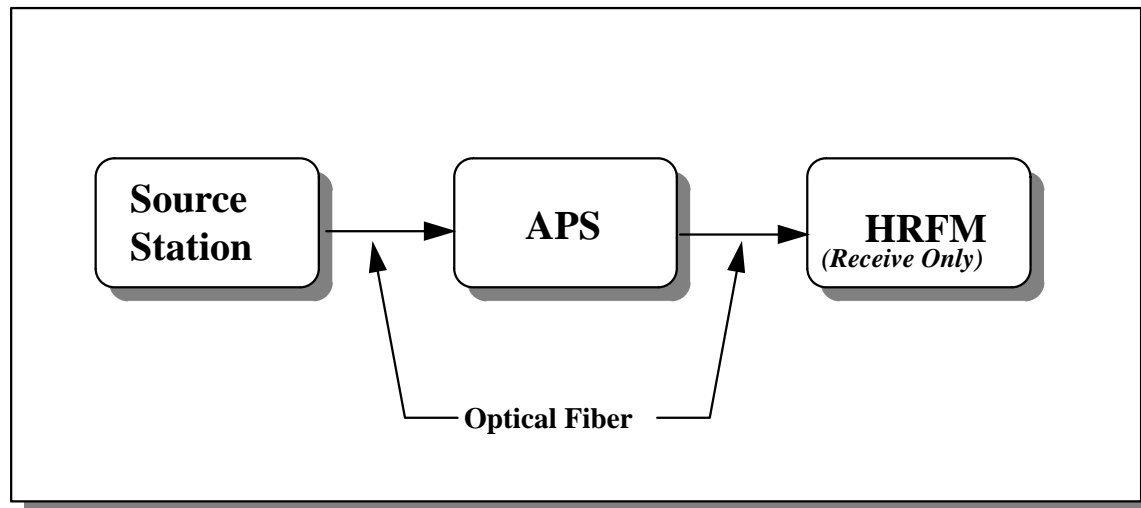

Figure 3.4.2.3-1 Typical Station-to-HRFM High Rate Data Link

3.4.2.4 HRFM PROTOCOL COMMON RULES

Protocol governing data rate allocation and control are common to both HRFM Modes and HRDL stations and implement these protocols in order to ensure successful HRDL communications. The following subsections define the rules governing HRDL data rates during transmission to the HRFM.

3.4.2.4.1 DATA RATES

3.4.2.4.2 DATA RATES FROM THE HRDL TO THE HRFM

This section describes data rates from the HRDL to the HRFM for downlinking through the Ku-Band system. Failure to meet the following sections will cause the HRFM to stop processing data on the offending input.

3.4.2.4.3 ALLOCATED DATA RATES

HRDL transmit stations shall{3.4.2.4.3-A} provide the capability to transmit data up to a maximum rate of 43.195 Mbps (50 Mbps including CCSDS overhead) in increments of 0.43195 Mbps (0.5 Mbps including CCSDS overhead). The HRFM has 8 HRDL and 4 video inputs, where the aggregate input data rate is 43.195 Mbps. The allocated data rate is determined by negotiation between the parties responsible for the transmit station and HRFM operations. The transmit station shall{3.4.2.4.3-B} limit the maximum data rate to the negotiated (i.e., allocated) data rate. This allocated rate is set by the Payload Operations Integration Center (POIC) on a case by case basis.

3.4.2.4.4 BURST DATA RATES

Stations may momentarily transmit burst data to the HRFM at data rates exceeding the allocated data rate. Burst data cannot exceed the maximum frame size of 4096 Bytes or 32768 bits and must insert Interpacket Gaps between the burst packets according to the following formula.

$$\text{Interpacket Gap (sec)} = \left. \begin{array}{l} \text{Greater} \\ \text{of the} \\ \text{following} \\ \text{values:} \end{array} \right\} \begin{array}{l} \text{Number of Bits} * \left(\frac{1}{\text{Allocated Data Rate}} - \frac{1}{\text{Burst Data Rate}} \right) \\ \\ \text{-- OR --} \\ \\ 2 \text{ microseconds (i.e., 25 SYNCS)} \end{array}$$

3.4.2.4.4.1 EVENLY-PARSED DATA

Stations may evenly parse data onto the HRDL at the byte level such that bytes presented on the HRDL link are separated by an equal number of Sync symbols. Shown in Figure 3.4.2.4.1.3.1-1, Example of Evenly-Parsed Data on HRDL, is an example of evenly parsed data corresponding to a transmitted data rate of 20 Mbps. In this example, four (4) Sync symbols are inserted between every 4B/5B encoded data byte.

Stations that evenly parse data onto the HRDL at the byte level, and at a rate that does not exceed the negotiated data rate, do not have to insert the Interpacket Gap defined herein except between the End and Start Delimiters of adjacent frames while in Frame Format Mode.

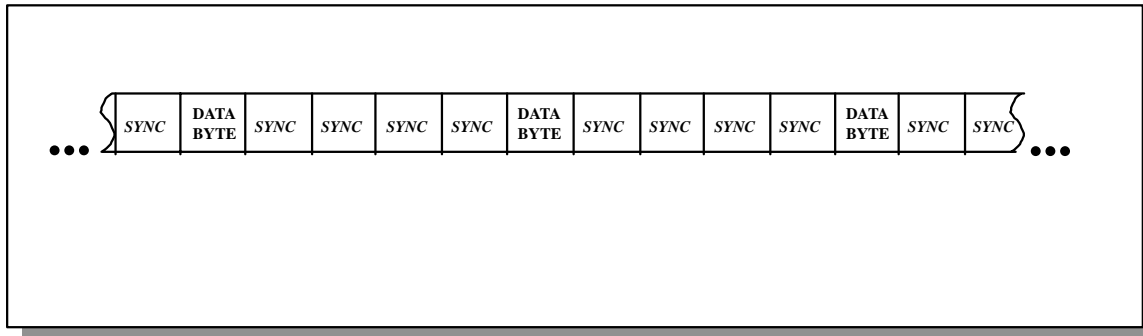

Figure 3.4.2.4.4.1–1 Example of Evenly–Parsed Data on HRDL

3.4.2.4.5 HRFM MODE STATES

The HRDL state diagram for the two (2) HRFM Modes: Bitstream Mode and Frame Format Mode is shown in Figure 3.4.2.4.2–1, Mode State Diagram for HRFM Modes. Transitions between the states shown in this diagram shall {3.4.2.4.5–A} occur only between states linked by arrows and only in the direction of these arrows – all other state transitions are forbidden. Additionally, transition from a state is allowed only after a set of exit criteria has been met.

Once the Initialization state is exited, either data or Sync symbols is present on the link at all times until the communications session is complete.

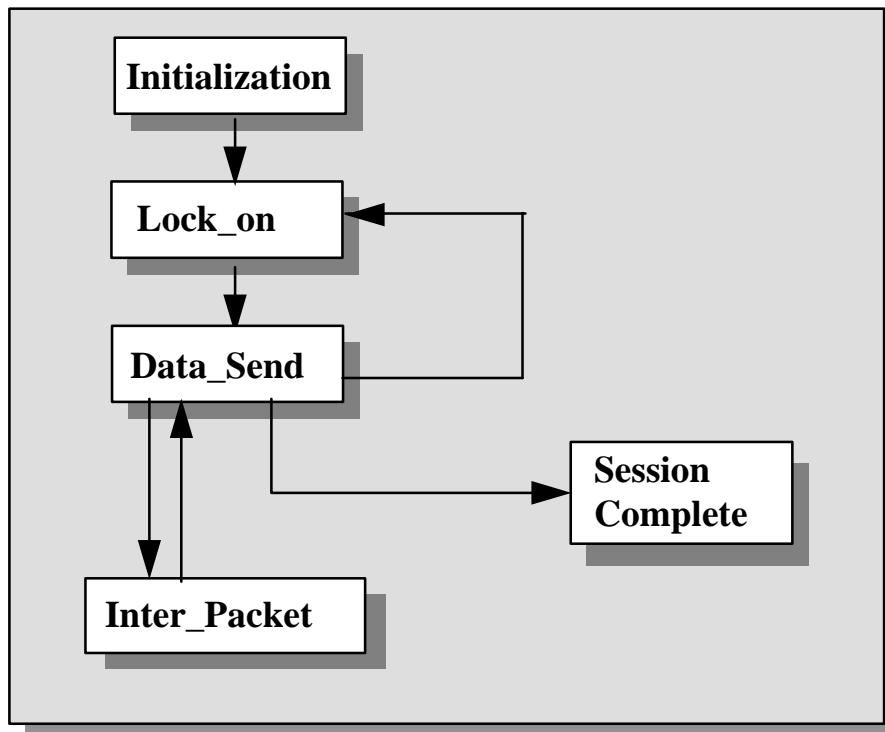

Figure 3.4.2.4.2–1 Mode State Diagram for HRFM Modes

3.4.2.4.6 INITIALIZATION STATE

This state consists of the actions which HRDL users must take prior to initializing station-to-HRFM communications. As a minimum, these actions consist of the following:

- a. Power-on to HRDL Transmit/Receiver circuitry in HRFM, APS and transmitting station.
- b. Establish station-to-station HRDL interconnect via MIL-STD-1553B message to APS
- c. Establish station Transmit and Receiver Data Rates and data framing formats (i.e., Bitstream or CCSDS Packet) via MIL-STD-1553B messages to HRFM and transmitting station.

The Initialization state shall{3.4.2.4.6–A} be considered complete when the transmit station, the HRFM, and the APS have been initialized, and a HRDL physical path between them has been established.

3.4.2.4.7 LOCK-ON STATE

In the Lock-On state, the transmit station shall{3.4.2.4.7–A} send a minimum of 1250 Sync symbols (i.e., 100 usec) over the HRDL network via the APS to the HRFM in order to ensure that their receivers are locked. Typically, this state will be reached by default as the ORU

transmit and receive elements are powered on during the Initialization State; however, users should verify that this state is attained. The Lock-On state is consistent with the PLL state, as described in the TAXI vendor documentation.

The Lock-On state shall{3.4.2.4.7-B} be considered complete when the transmit station presents a minimum of 1250 Sync symbols (i.e., 100 usec) to the APS and HRFM over the HRDL. Also, a contiguous string of symbols shall{3.4.2.4.7-C} continue to be sent.

3.4.2.4.8 DATA-SEND STATE

HRDL stations remain in Data-Send State while transmitting data packets according to the data transmission rules established herein.

In this state, the HRDL station shall{3.4.2.4.8-A} insert Interpacket Gaps onto the HRDL network, as necessary to meet the requirements in paragraph 3.3.2.1.1.2.

The Data_Send state shall{3.4.2.4.8-B} be considered complete when the data transmission is complete, or when a command is received to change HRFM protocols between CCSDS Packet and Bitstream. At this point, the transmit station, receive station, and the APS can terminate this HRDL transmission, or return to the Lock-On state for another HRDL transmission in a different HRFM protocol.

3.4.2.4.9 RECONFIGURE STATE

The station and HRFM transition to the Reconfigure State to allow modification to the negotiated data rate via MIL-STD-1553B commands. While in this state, no data is transmitted on the HRDL. The station present a contiguous stream of Syncs on the HRDL in order to keep the HRFM's receiver locked. The state is exited when both stations have been initialized with the new negotiated data rate.

3.4.2.5 HRFM BITSTREAM MODE RULES

Rules specific to the HRFM Bitstream Mode consists of rules governing data formatting. Framing data for HRFM Bitstream mode shall{3.4.2.5-A} be presented on the HRDL as an unformatted bitstream containing no Start or End Delimiters or CCSDS packetization. The absence of formatting in this mode is illustrated in Figure 3.4.2.5-1, High Rate Data Link Bitstream Format.

In Bitstream protocol, the HRDL transmit station shall{3.4.2.5-B} transmit data on the HRDL network as an unformatted bitstream containing no Start or End Delimiters or CCSDS packetization. The absence of formatting in this mode is illustrated in Figure 3.4.2.5-1, High Rate Data Link Bitstream Format.

The HRDL transmit station shall {3.4.2.5-C} transfer Bitstream data to the HRFM over the HRDL network on 16 bit word boundaries (i.e., blocks of data equivalent to two bytes). The HRFM will load a value of 07FF (hex) into the “Bitstream Pointer” field of all Bitstream Protocol Data Unit (BPDU) headers with a full data field instead of 3FFF (hex).

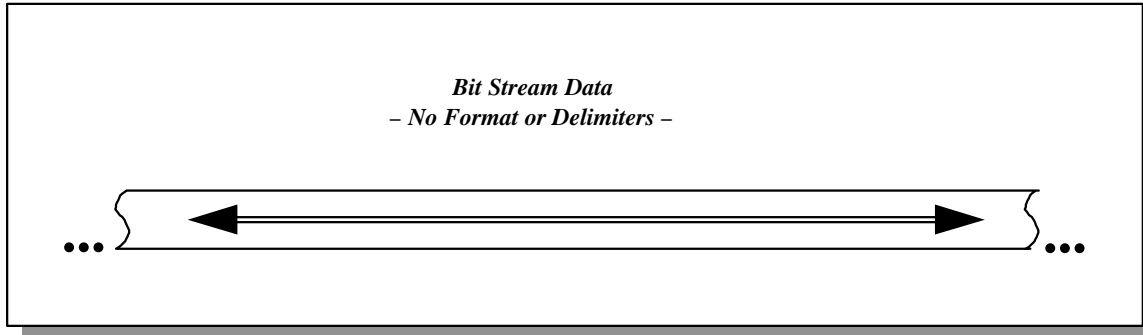

Figure 3.4.2.5-1 High Rate Data Link Bitstream Format

APPENDIX A PAYLOAD MDM LOCAL BUS PROFILES

The Payload MDM Local Bus Profiles may be found on the following six pages.

Payload MDM Local Bus PL-1 I/O Profile

100 ms Processing Frame

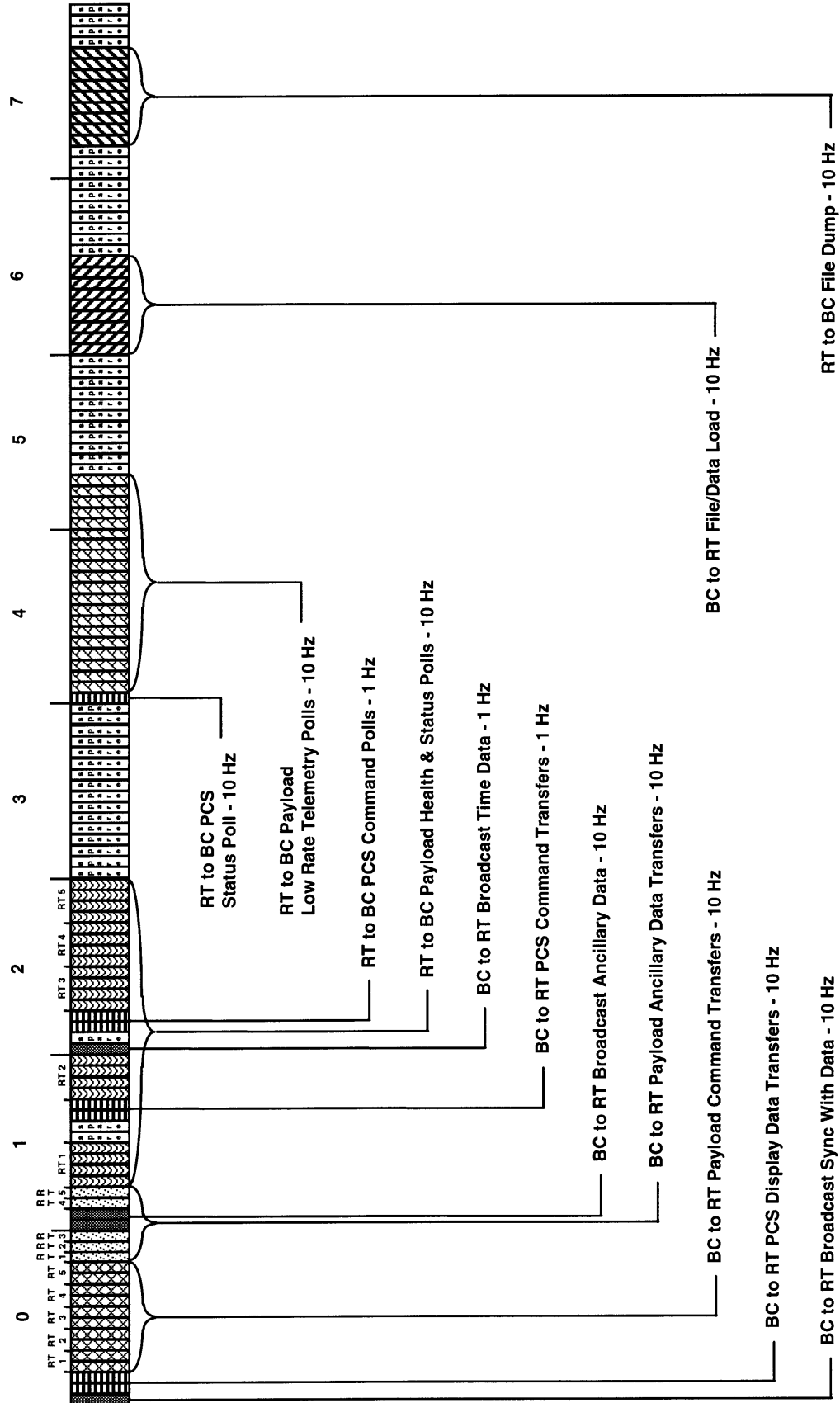

Payload MDM Local Bus PL-3 I/O Profile

← 100 ms Processing Frame →

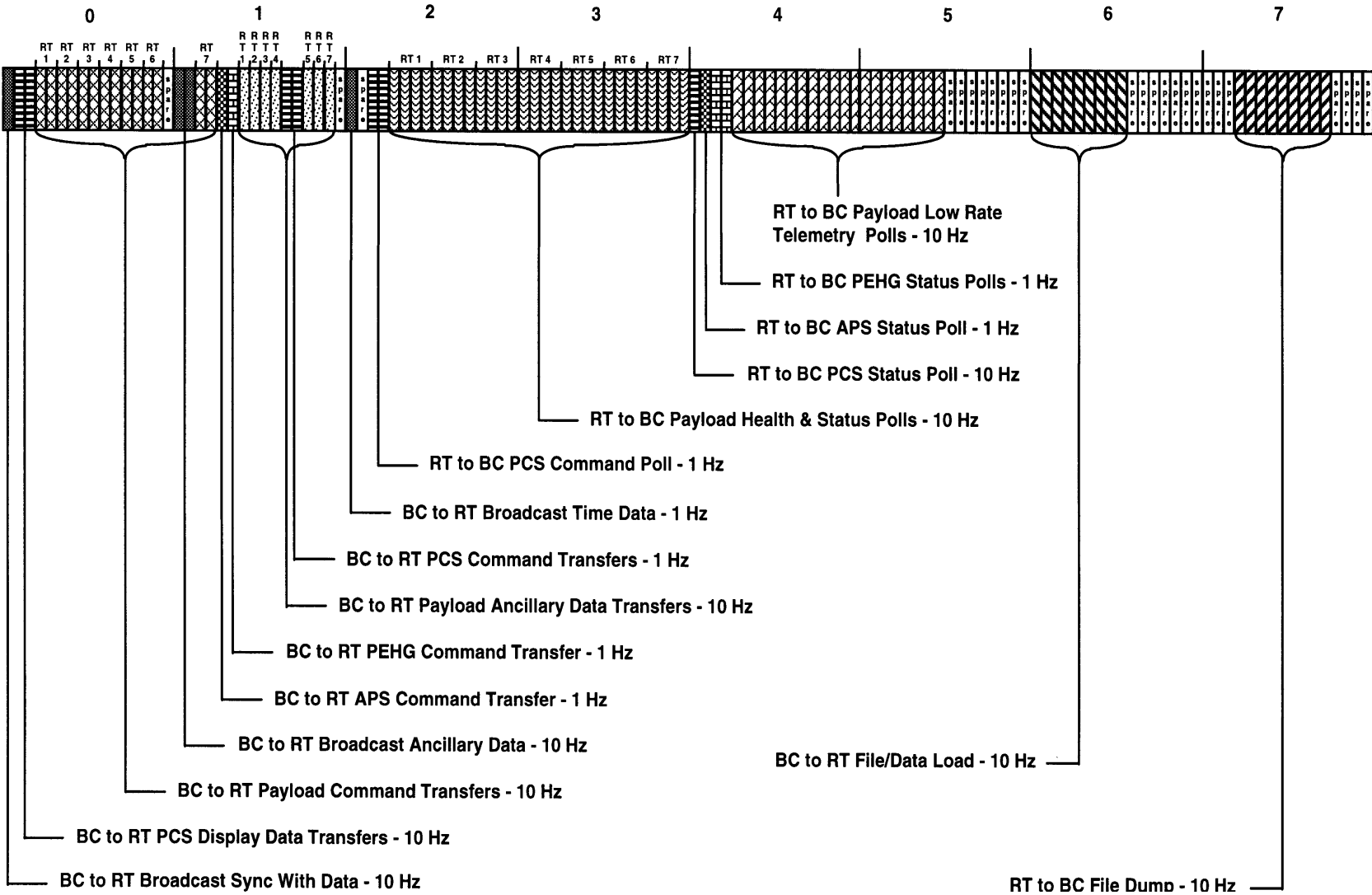

A-4

Payload MDM Local Bus PL-JEM I/O Profile

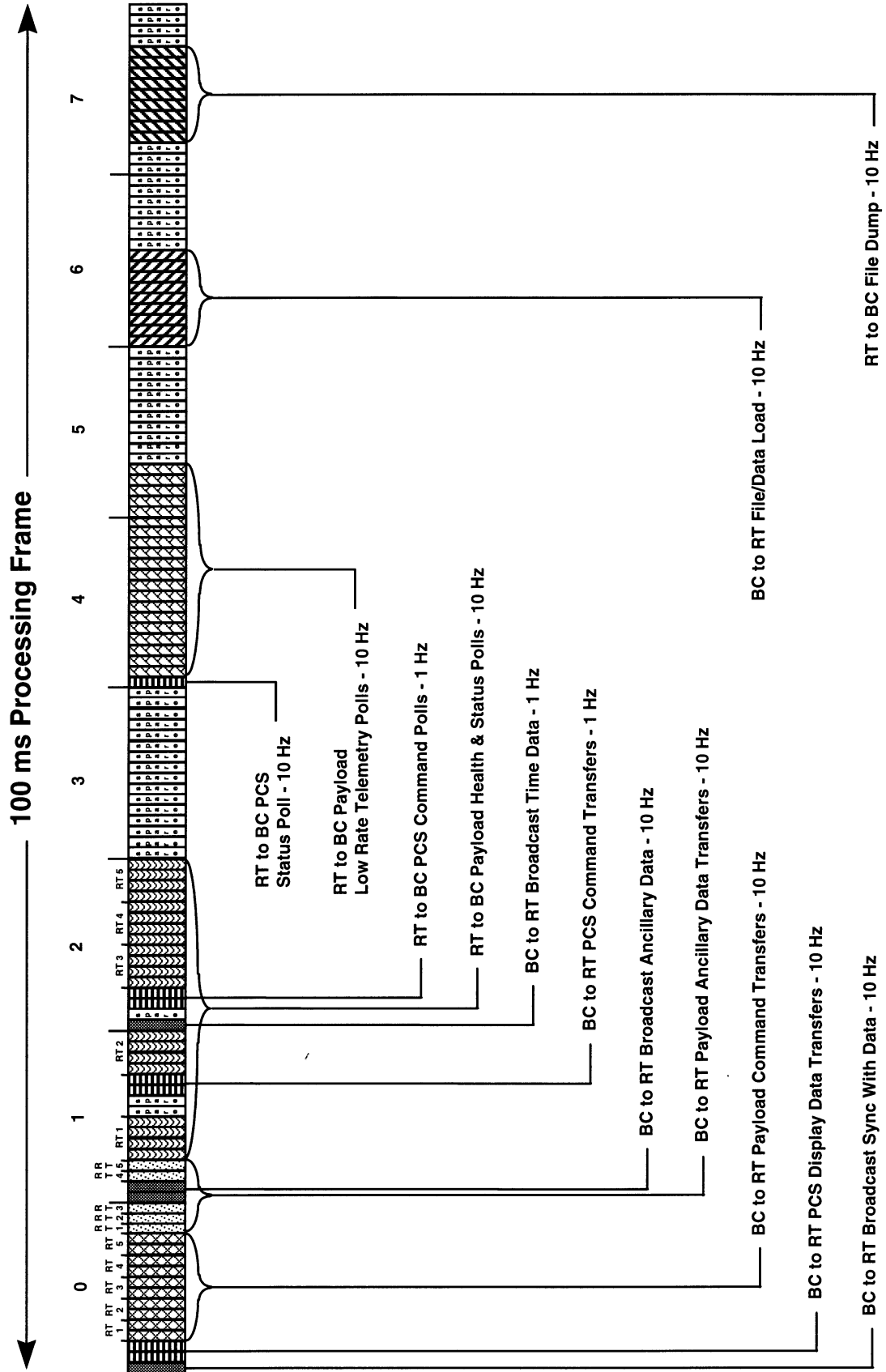

APPENDIX B ABBREVIATIONS AND ACRONYMS

AIT	Analyses and Integration Team
APID	Application Identifier
APM	Attached Pressurized Module
APS	Automated Payload Switch
B	Binary
BC	Bus Controller
BER	Bit Error Rate
BIT	Built In Test
BPDU	Bitstream Protocol Data Unit
C&W	Caution & Warning
CCS	Command and Control Software
CCSDS	Consultative Committee for Space Data Systems
CRC	Cyclic Redundancy Check
CSM/CA	Carrier Sensed Multiple Access with Collision Detection
DW	Data Word
ED	End Delimiter
EXPRESS	EXpedite the PROcess of Experiments to Space Station
FDDI	Fiber Distributed Data Interface
FO	Fiber Optic
H	Hexadecimal
H&S	Health & Status
HRDL	High Rate Data Link
HRFM	High Rate Frame Multiplexer

ICD	Interface Control Document
ID	Identifier
ISPR	International Standard Payload Rack
JEM	Japanese Experiment Module
LLC	Layer Link Control
LSB	Least Significant Bit
Max	Maximum
Mbps	Megabits per second
MBaud	Megabaud
MDM	Multiplexer–Demultiplexer Module
min	minimum
Mbps	Mega bits per second
MBps	Mega Bytes per second
MPDU	Multiplexed Protocol Data Unit
MRDL	Medium Rate Data Link
ms	Millisecond
MSB	Most Significant Bit
NASDA	National Space and Development Agency of Japan
NASA	National Aeronautics and Space Administration
nm	Nanometer
NRZI	Non Return to Zero Invert on Ones
ns	Nanosecond
O	Octal
ORU	Orbital Replacement Unit
PCS	Portable Computer System

PD	Payload Developer
PD/PI	Payload Developer/Payload Integrator
PDU	Protocol Data Unit
PEHG	Payload Ethernet Hub Gateway
PEP	Payload Executive Processor
PI	Payload Integrator
PL	Payload
PLL	Phase Locked Loop
PLMDM	Payload Multiplexer/Demultiplexer
POIC	Payload Operations Integration Center
PSRP	Payload Safety Review Panel
RIC	Rack Interface Controller
Rx	Receiver
RT	Remote Terminal
SA	Subaddress
SAM	Subaddress Mode
SD	Start Delimiter
sec	seconds
SFD	Start Frame Delimiter
SSCB	Space Station Control Board
TAXI	Transparent Asynchronous Transmitter–Receiver Interface
Tx	Transmitter
T/R	Transmit/Receive
us	Microsecond
USL	United States Laboratory

USOS

United States On-Orbit Segment

1553

Mil-Std-1553B Data Bus

APPENDIX C GLOSSARY OF TERMS

4B/5B ENCODING

On the HRDL link, five (5) signaling bits are used to represent four (4) data bits (i.e., 4B/5B). Consequently, using 4B/5B encoding, it takes 125 MBaud to encode 100 Mbps of data.

ALLOCATED DATA RATE

See **NEGOTIATED DATA RATE**.

BAUD

A HRDL signaling bit. For the HRDL, five (5) signaling bits are used to represent four (4) data bits (i.e., 4B/5B). Consequently, using 4B/5B encoding, it takes 125 MBaud to encode 100 Mbps of data.

BURST DATA RATE

A HRDL data rate that is momentarily greater than the Allocated Data Rate.

DATA RATE

The rate that data is actually being sent across the HRDL. The maximum data rate is 80% of the constant 125 MBaud Signaling Rate. Data rates lower than the maximum data rate do not necessitate a change in the 125 MBaud Signaling rate due to the insertion of Sync symbols on the link.

ELEMENT

Refers to the module or truss segment for which a Product Group (PG) or IP has final integration responsibility. Consequently, they are also referred to as “End-Items”.

END-ITEM

See Element.

FRAME

One or more packets forming a delineated group of packets. This packet group is delineated from other packet groups by Start and End Delimiters, and uniquely identified by its six (6) byte Frame Header.

INTERFRAME GAP

The mandatory gap which must be inserted between the End and Start Delimiters of adjacent data frames destined for the HRFM. This gap is determined by the same formula used to determine Interpacket Gaps. *See Interpacket Gap.*

INTERPACKET GAP

The mandatory gap which must be inserted between adjacent data packets. This gap consists of the insertion of a contiguous string of Sync symbols whose size is dictated by the Interpacket Gap formula as follows:

$$\text{Interpacket Gap (sec)} = \left. \begin{array}{l} \text{Greater} \\ \text{of the} \\ \text{following} \\ \text{values:} \end{array} \right\} \begin{array}{l} \text{Number of Bits} * \left(\frac{1}{\text{Allocated Data Rate}} - \frac{1}{\text{Burst Data Rate}} \right) \\ \\ \text{-- OR --} \\ \\ 2 \text{ microseconds (i.e., 25 SYNCS)} \end{array}$$

NEGOTIATED DATA RATE

The maximum HRDL data rate that has been agreed to by the parties responsible for the transmitting and receiving HRDL stations. This data rate is determined prior to the initialization of HRDL communications.

PACKET

A contiguous string of HRDL bits whose maximum length may not exceed 32768 bits (i.e., 4096 bytes).

RECEIVE STATION

The receive station is the destination of the HRDL data transmission, where the data is ultimately retrieved from the HRDL network. By this definition, the APS is not a receive station. The HRFM is a special type of receive station, that does not have to comply with the requirements of the receive station.

SIGNALING RATE

The number of Baud (i.e., signaling bits) which are transmitted per second. The HRDL Signaling Rate is a fixed 125 MBaud.

STATION

Stations are all entities which transmit and/or receive data across the HRDL. By this definition, the APS and HRFM are stations.

TRANSMIT STATION

The transmit station is the source of the HRDL data transmission, where the data is initially placed onto the HRDL network. By this definition, the APS is not a transmit station.

APPENDIX D SUMMARY OF CCSDS SECONDARY HEADER TAILORING

The CCSDS secondary header is tailored as follows:

- A. Commands from the ground, PCS, or Timeliner to the ISPR:
 - (1) Word #6: The Packet Type will contain a value of '1010'B (RT/Payload Command) per Table 3.3.2.1.1–2 of SSP 41175–2.
 - (2) Word #7: Per SSP 41175–2, Section 3.3.2.1.1 and Figure 3.3.2.1.1–2.
 - (3) Word #8: Will contain the Subset ID of the payload/subrack payload being commanded.

- B. File Transfer Data from the PEP to the ISPR:
 - (1) Word #6: The Packet Type is not processed by the PEP and should not be processed by the RT.
 - (2) Word #7 and Word #8: Will contain “meaningless” data and should not be processed by the RT.

- C. Request Responses from the PEP to the ISPR:
 - (1) Word #6: The Packet Type will contain a value of '0100'B (Telemetry/Status) per Table 3.3.2.1.1–2 of SSP 41175–2.
 - (2) Word #8: Will contain the Subset ID of the entity which made the request.

- D. Ancillary Data from the PEP to the ISPR:
 - (1) Word #6: The Packet Type will contain a value of '0111'B (Ancillary Data) per Table 3.3.2.1.1–2 of SSP 41175–2.
 - (2) Word #8: Will contain the Subset ID of the entity which requested the Ancillary Data Set.

- E. Telemetry (Low Rate, Medium Rate, or High Rate) from the ISPR:
 - (1) For payload telemetry data to be processed at the HOSC:
 - a. Word #6: The Packet Type value is not processed by the PEP or the ground systems and is “don't care”.
 - b. Word #7: Will contain a Version ID, which is an unsigned integer and identifies the overall data structure of the data in the packet, and serves as a reference to a specific pre-defined KU-Band telemetry data format contained in ground configuration data.
 - c. Word #8: Will contain a Data Cycle Counter, which will contain an unsigned integer ranging from 1..65535, and will identify a given packet as being packet number “n” in an “m” packet data set.

- (2) For payload telemetry data that is processed only at the Telescience Support Center or Payload Developer/Payload Integrator site:
 - a. Tailoring of the CCSDS secondary header is left to the discretion of the Payload Developer/Payload Integrator.
- F. File Transfer Data from the ISPR to the PEP
 - (1) The Payload MDM does not process the CCSDS secondary header. Rather, it reads the packet length in the primary header and then removes the entire CCSDS header from the data packets. Therefore, all values in the CCSDS secondary header are "don't care".
- G. Health & Status Data from the ISPR to the PEP
 - (1) The Payload MDM does not process the CCSDS secondary header. Rather, it reads the packet length in the primary header and then removes the entire CCSDS header from the data packets. Therefore, the values in the CCSDS secondary header are "don't care".