

This Drawing is the property of Poseidon Scientific Instruments Pty. Ltd. and is strictly confidential. No part or parts of this document may be reproduced, stored in a retrieval system or transmitted in any form by any means (including electronic mechanical photocopying or otherwise) without the written permission of Poseidon Scientific Instruments Pty. Ltd.

SPECIFICATIONS	
UNITS	MILLIMETERS
TOLERANCES	± 0.1 mm UNLESS STATED
MATERIAL	ALUMINIUM 6061 - T6
FINISH	3.2 SURFACE UNLESS STATED ALODYNE DIP - STREAK FREE

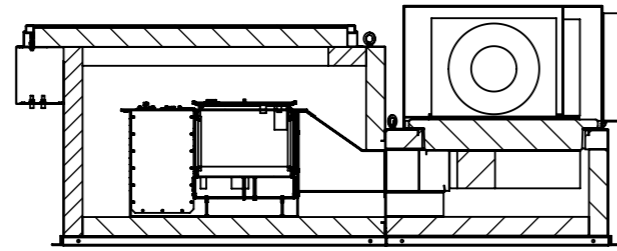

SECTION F-F  
SCALE 1 : 20

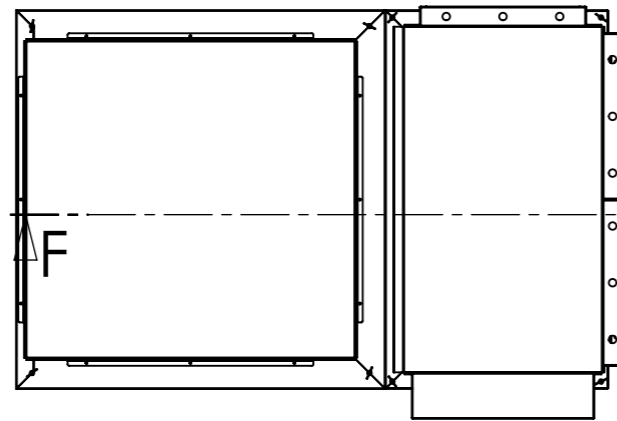
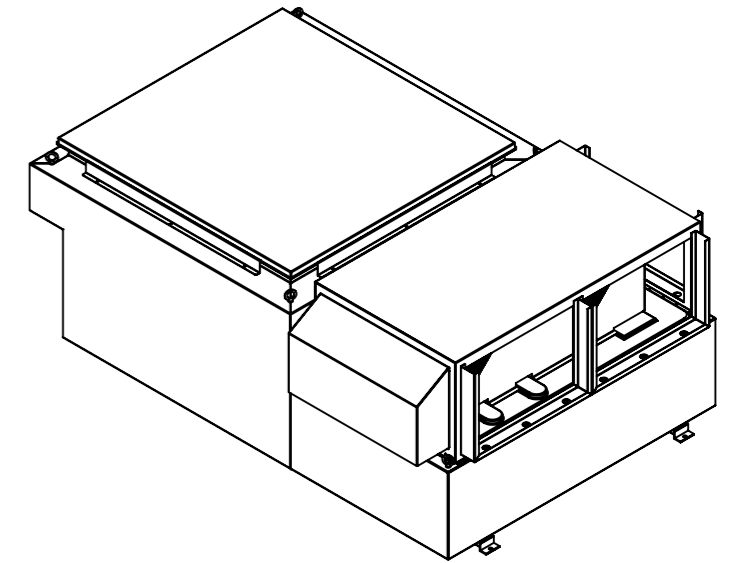

SECTION A-A  
SCALE 1 : 20

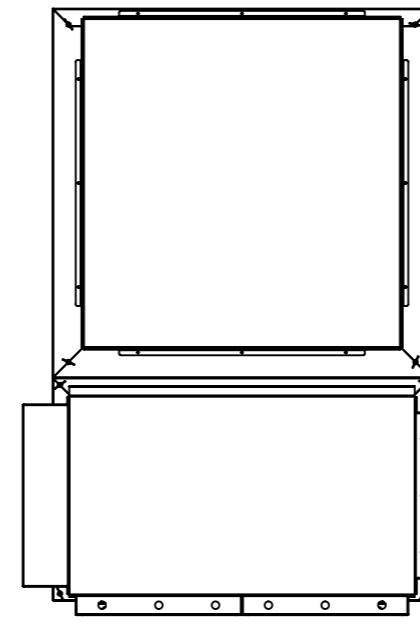

SECTION C-C  
SCALE 1 : 20

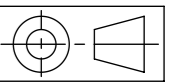
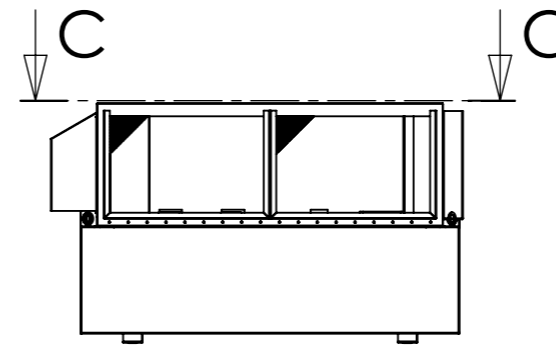
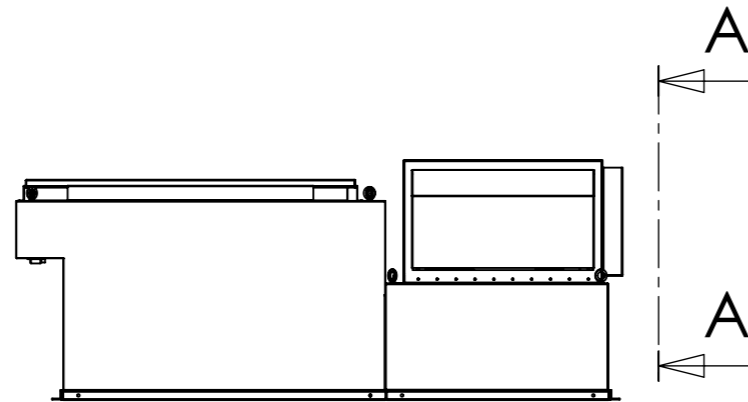

 <b>POSEIDON SCIENTIFIC INSTRUMENTS</b> <small>17 QUEEN VICTORIA ST, FREMANTLE WA 6160 PH: (08) 9430 6639 FAX (08) 9335 4650</small>			
DRAWING NAME			
<b>MWA MAIN ENCLOSURE</b>			
SIZE	DRAWN BY	DRAWING FILENAME.	
A3	I MOORE	MWAM001 Main enclosure.SLDRW	
SCALE	DATE	COMPONENT NAME	REV
1:10	20/10/2009	MWAM001 Main enclosure.SLDPRT	A
SHEET			
1 of 1			