

REVISIONS				
ECD	REV.	DESCRIPTION	DATE	APPROVED
32-117	01	INITIAL RELEASE	4/27/2006	

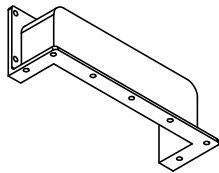
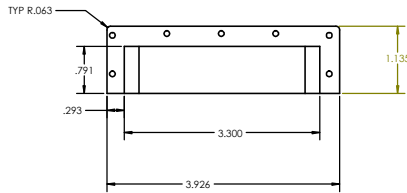
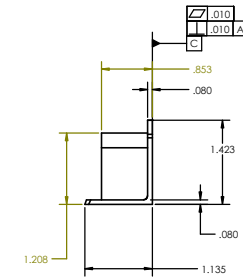
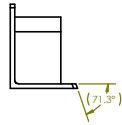
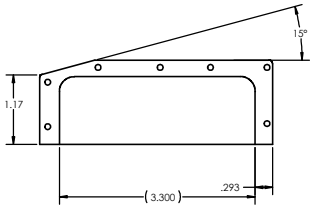
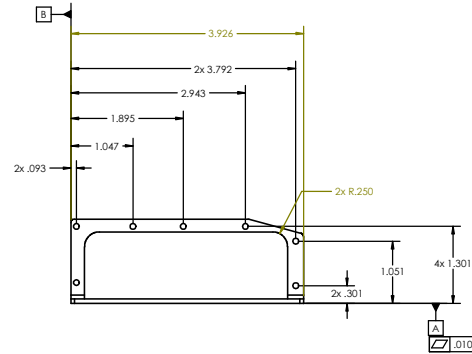
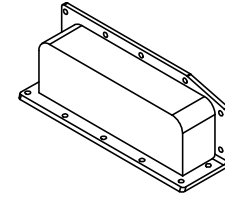
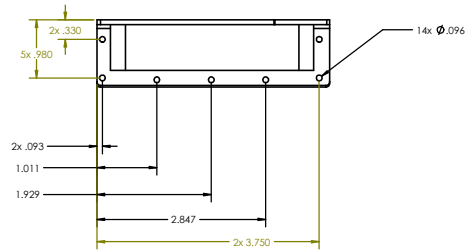
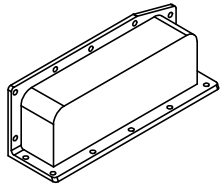

- NOTES.
1. DEBURR AND BREAK SHARP EDGES
 2. MIN INSIDE RAIUS TO BE .005 MAX
 3. BAG AND TAG WITH MIT PART NUMBER AND REV LETTER.

UNLESS OTHERWISE SPECIFIED:
 DIMENSIONS ARE IN INCHES
 TOLERANCES:
 ANGULAR DIMS ± .1°
 HOLE LOCATIONS ± .010
 HOLE SIZE ± .0015
 UNLESS OTHERWISE SPECIFIED:
 SURFACE FINISH:
 ALL SURFACES PER MIL-C-8841, CL3

DATE	NAME	DATE	MIT, CRATER PROJECT
	DRAWN		TITLE:
	CHECKED		COVER, CONNECTOR ACCESS
	ENG APPR.		
	ENG APPR.		
COMMENTS:		SIZE	DWG. NO.
		D	32-20206
		SCALE: 1:2	WEIGHT:
			REV
			01
			SHEET 1 OF 1