

# CRaTER

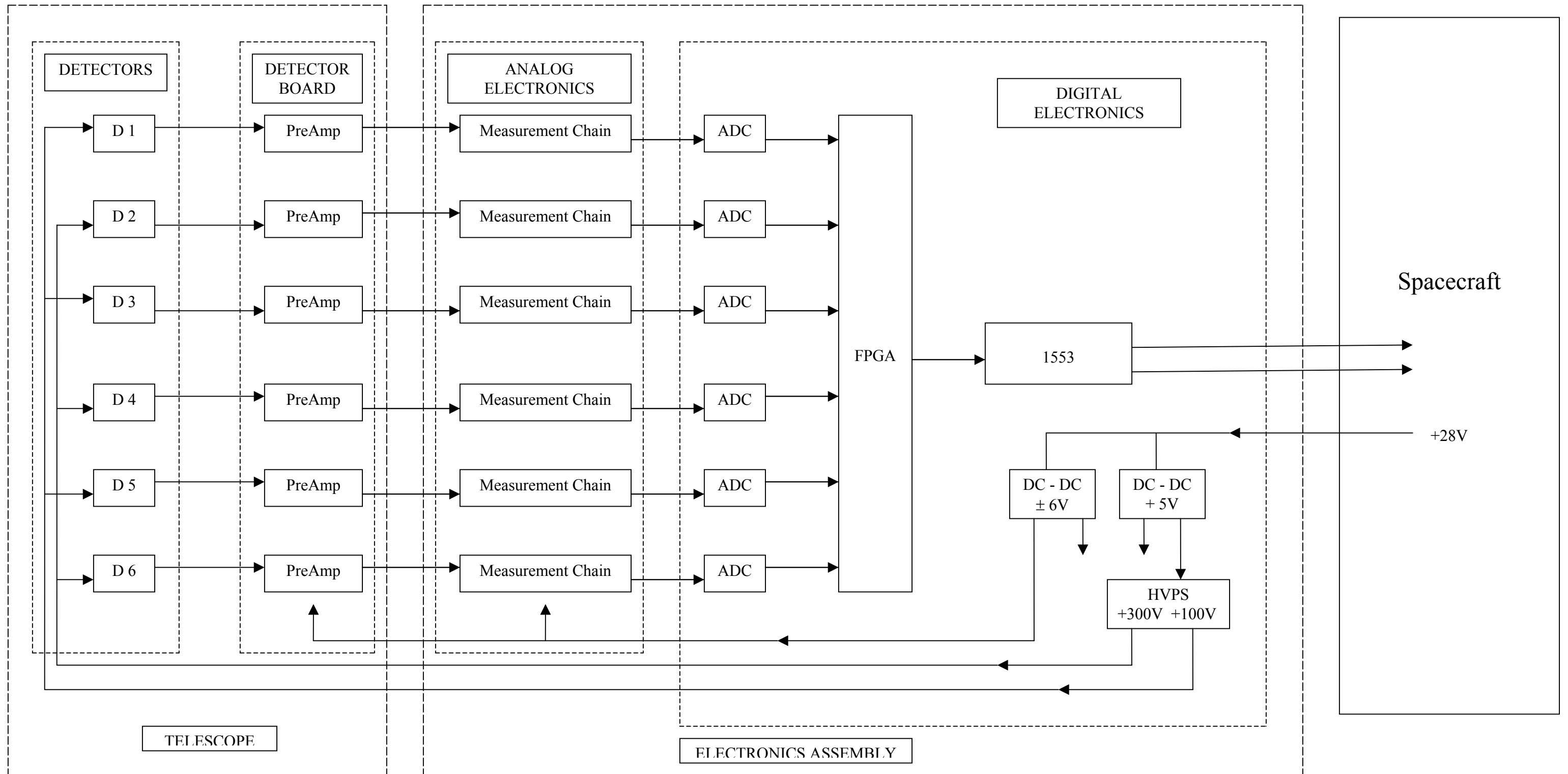

## Reliability Block Diagram

32-04003.01, Rev. 02