

National Aeronautics and
Space Administration

Lyndon B. Johnson Space Center
Houston, Texas 77058

October 2004

Interface Definition Document (IDD)
for the
Human Research Facility (HRF)
Rack 2 Workstation (R2WS)

LS-71042-14-4B

PROJECT DOCUMENT APPROVAL SHEET

DOCUMENT NUMBER

LS-71042-14-4B

DATE

10/22/04

**NO. OF
PAGES**

55

TITLE:

Interface Definition Document (IDD)
for the
Human Research Facility (HRF)
Rack 2 Workstation (R2WS)

APPROVED:

EB/G. Valle
Technical Manager

Original Signature on File 10/22/04

DATE

PREPARED BY

CHANGE APPROVALS

**CHANGE
NUMBER**

DOCUMENT NUMBER LS-71042-14-4	DOCUMENT CHANGE/ REVISION LOG	PAGE <u> 1 </u> OF <u> 1 </u>
----------------------------------	--	-----------------------------------

CHANGE/ REVISION	DATE	DESCRIPTION OF CHANGE	PAGES AFFECTED
Basic	03/09/01	Baseline Issue	All
A	3/18/02	Complete Revision	All
B	10/22/04	Complete Revision	All

Altered pages must be typed and distributed for insertion.

CONTENTS

Section		Page
1.0	<u>INTRODUCTION</u>	1-1
1.1	PURPOSE	1-1
1.2	SCOPE	1-1
2.0	<u>REFERENCE DOCUMENTS</u>	2-1
3.0	<u>RACK 2 WORKSTATION INTERFACES</u>	3-1
3.1	ELECTRICAL INTERFACES	3-1
3.1.1	<u>HRF R2WS to Rack – Rear Power Connector (J1)</u>	3-1
3.1.2	<u>HRF R2WS to Other Payloads – 28 V Power Connector (J11)</u>	3-2
3.1.3	<u>Front Panel Power</u>	3-2
3.2	DATA INTERFACES	3-3
3.2.1	<u>HRF R2WS to Rack – Rear Data Connector (J2)</u>	3-3
3.2.2	<u>HRF R2WS to Other Payloads</u>	3-6
3.2.2.1	Analog-to-Digital (A/D), Digital-to-Analog (D/A), Digital Input/Output (DIO) Connector (J3)	3-6
3.2.2.2	VGA/Keyboard Connector (J4)	3-11
3.2.2.3	IRIG-B Connector (J6)	3-12
3.2.2.4	Compact Disc/Digital Versatile Disc (CD/DVD) (J8)	3-13
3.2.2.5	Ethernet Connector (J9)	3-14
3.2.2.6	UNIVERSAL SERIAL BUS (USB)/IEEE 1394 Connector (J10)	3-15
3.3	AUDIO/VIDEO INTERFACES	3-16
3.3.1	<u>National Television Systems Committee/Audio Connector (J5)</u>	3-16
3.3.2	<u>RGB Connector (J7)</u>	3-17
3.4	HUMAN INTERFACES	3-18
3.4.1	<u>Keyboard</u>	3-18
3.4.2	<u>Display</u>	3-18
3.4.3	<u>Light-Emitting Diode</u>	3-21
3.5	MECHANICAL INTERFACES	3-21
3.6	THERMAL INTERFACES	3-21
4.0	<u>CABLES</u>	4-1
4.1	VGA/KEYBOARD/MOUSE CABLE	4-3
4.2	ANALOG-TO-DIGITAL LOOPBACK CABLE	4-3
4.3	USB/IEEE 1394 CABLE	4-3
4.4	WS2 HEADSET ASSEMBLY	4-4
4.5	A/V CABLE	4-4
4.6	RGB CABLE	4-4
4.7	RGB BREAKOUT CABLE	4-5
4.8	WS2 ETHERNET CONNECTOR SAVER	4-5
4.9	ETHERNET CROSSOVER CABLE	4-5

CONTENTS (Cont'd)

Section		Page
5.0	<u>HARDWARE DESCRIPTION</u>	5-1
5.1	<u>RACK CONFIGURATION</u>	5-2
5.1.1	<u>Launch/Stowage Configuration</u>	5-2
5.1.2	<u>Deployed Configuration</u>	5-2
5.2	<u>HARDWARE PRIMARY COMPUTER BOARD ASSEMBLIES</u>	5-2
5.2.1	<u>Summary of HRF R2WS Computer Drawer Hardware Components</u>	5-3
5.2.2	<u>Passive Backplane</u>	5-3
5.2.3	<u>Central Processing Unit Board (AGP/PCI Card)</u>	5-3
5.2.4	<u>Anti-Aliasing Board (ISA Board)</u>	5-4
5.2.5	<u>IEEE 1394/USB Controller (PCI Card)</u>	5-4
5.2.6	<u>Ultra 160 SCSI Controller (PCI Card)</u>	5-5
5.2.7	<u>Analog-to-Digital Board (PCI Card)</u>	5-5
5.2.8	<u>Video Card (AGP Card)</u>	5-6
5.2.9	<u>PCMCIA Controller (PCI Card)</u>	5-7
5.2.10	<u>Isolation Board</u>	5-7
5.2.11	<u>Video Buffer Board</u>	5-7
5.2.12	<u>Interchangeable Drive Bay</u>	5-7
6.0	<u>OPERATIONAL SCENARIOS</u>	6-1
	APPENDIX A	A-1

TABLES

Table		Page
3-1	PIN ASSIGNMENT FOR CONNECTOR J1 (REAR POWER CONNECTOR)	3-1
3-2	FRONT PANEL POWER PINS	3-2
3-3	BACK PANEL CONNECTOR PINS USED BY HRF R2WS	3-4
3-4	INTERFACE SPECIFICATIONS FOR CONNECTOR J3 (A/D, D/A, DIO)	3-7
3-5	PIN ASSIGNMENTS FOR CONNECTOR J3 (A/D, D/A, DIO)	3-9
3-6	PIN ASSIGNMENTS FOR CONNECTOR J4 (VGA/KEYBOARD)	3-11
3-7	PIN ASSIGNMENTS FOR CONNECTOR J6 (IRIG-B)	3-12
3-8	PIN ASSIGNMENTS FOR CONNECTOR J8 (CD/DVD)	3-13
3-9	PIN ASSIGNMENTS FOR CONNECTOR J9 (ETHERNET)	3-14
3-10	PIN ASSIGNMENTS FOR CONNECTOR J10 (USB/IEEE 1394)	3-15
3-11	PIN ASSIGNMENTS FOR CONNECTOR J5 (NTSC/AUDIO CONNECTOR)	3-16
3-12	PIN ASSIGNMENTS FOR CONNECTOR J7 (RGB VIDEO)	3-17
3-13	HRF ULTRASOUND VIDEO REQUIREMENTS	3-19
3-14	PIN ASSIGNMENTS FOR HRF FSD WORKSTATION CONNECTOR	3-20
3-15	PIN ASSIGNMENTS FOR HRF FSD ULTRASOUND (US) CONNECTOR	3-20
3-16	PIN ASSIGNMENTS FOR HRF FSD POWER CONNECTOR	3-21
5-1	HRF R2WS COMPUTER PWB ASSEMBLIES PART NUMBERS	5-3
5-2	IDB ACCESSORIES	5-8

LIST OF FIGURES

Figure		Page
3-1	Rear Power Connector - Face View	3-1
3-2	28 V Power Connector Face	3-2
3-3	Rear Panel Data Connector - Face View	3-3
3-4	R2WS Front Panel Diagram	3-5
3-5	A/D, D/A, DIO Connector Face	3-10
3-6	VGA/Keyboard Connector Face	3-11
3-7	IRIG-B Connector Face	3-12
3-8	CD/DVD Connector Face	3-13
3-9	Ethernet Connector Face	3-14
3-10	USB/IEEE 1394 Connector Face	3-15
3-11	NTSC/Audio Connector Face	3-16
3-12	RGB Connector Face	3-17
4-1	Basic System Cabling	4-2
5-1	HRF R2WS Computer Boards	5-2
A-1	R2WS System Block Diagram	A-1
A-2	R2WS Isolation Board Block Diagram	A-2
A-3	Wiring and Fusing Diagram	A-3

ACRONYMS AND ABBREVIATIONS

A	Ampere
A/D	Analog-to-Digital
A/V	Audio/Video
AC	Alternating Current
ADC	Analog-to-Digital Converter
ADD	Address
AGP	Accelerated Graphics Port
ANLG	Analog
ATA	Advanced Technology Attachment
Aux	Auxiliary
AWG	American Wire Gauge
BIOS	Basic Input/Output System
BLURTN	Blue Return
°C	Degrees Celsius
CCB	Configuration Control Board
CD	Compact Disc
CD-ROM	Compact Disc Read-Only Memory
CLK	Clock
CMOS	Complementary Metal Oxide Semiconductor
CMP	Connection Management Protocol
CnC	Command and Control
COM	Communications Port
CPU	Central Processing Unit
CR	Change Request
CRC	Cyclic Redundancy Check
CS	Chip Select
CSEL	Cable Select
CTS	Clear-to-Send
D/A	Digital-to-Analog
DAC	Digital-to-Analog Converter
DAS	Data Acquisition System
dB	Decibel
DC	Direct Current
DIFF	Differential
DIG	Digital
DIO	Digital Input/Output
DIP	Dual In-line Package
DMA	Direct Memory Access
DMACK	DMA Acknowledge
DMARQ	DMA Request
DSP	Digital Signal Processor
DSR	Dataset Ready
DVD	Digital Versatile Disc

ACRONYMS AND ABBREVIATIONS (Cont'd)

EIA	Electronic Industries Association
EIDE	Enhanced Integrated Drive Electronics
Enet	Ethernet
ENOB	Effective Number of Bits
EOT	End-of-Tape
ESD	Electrostatic Discharge
Ext	External
°F	Degrees Fahrenheit
Fax	Facsimile
FCP	Function Control Protocol
FIFO	First-In, First-Out
FPS	Frames per Second
FSB	Front-Side Bus
FSD	Flat Screen Display
FSR	Full Scale Range
ft	Foot/Feet
GASMAP	Gas Analyzer System for Metabolic Analysis of Physiology
GB	Gigabyte
Gbyte	Gigabyte
GMT	Greenwich Mean Time
GND	Ground
GRNRTN	Green Return
H&S	Health and Status
H/W	Hardware
Hi	High
hr	Hour
HRF	Human Research Facility
HSYNC	Horizontal Synchronization
HW	Hardware
Hz	Hertz
I/O	Input/Output
IBM	International Business Machines Corporation
ICH	I/O Controller Hub
ID	Identifier
IDB	Interchangeable Drive Bay
IDD	Interface Definition Document
IDE	Integrated Drive Electronics
IEEE	Institute of Electrical and Electronic Engineers
in.	Inch/Inches
Inc.	Incorporated
IOCS	I/O Chip Select
IOR	I/O Read

ACRONYMS AND ABBREVIATIONS (Cont'd)

IORDY	I/O Ready
IOW	I/O Write
IR	Infrared
I-RGB	Interlaced Red Green Blue
IRIG-B	Inter-Range Instrumentation Group–Standard B
ISA	Industry Standard Architecture
ISS	International Space Station
JEIDA	Japan Electronic Industry Development Association
k	kilo (1,000)
KBD	Keyboard
kHz	Kilohertz
kPa	Kilopascal
ksamples/s	Kilosamples per Second
kV	Kilovolt
kΩ	Kilo-ohm
L2	Level Two
lbs	Pounds
LCD	Liquid Crystal Display
LED	Light-Emitting Diode
Lo	Low
LSB	Least Significant Bit
Ltd.	Limited
LVD	Low-Voltage Differential
μF	microFarad
μs	Microsecond
μV	microVolts
m	meter
mA	milliAmperes
MAC	Media Access Control
MB	Megabyte (approximately one million bytes)
MB/sec	Megabytes per second
mBar	milliBar
Mbit	Megabit
MHz	MegaHertz
Mic	Microphone
MIL-SPEC	Military Specification
MS CLK	Mouse Clock
ms/hr	millisecond/hour
Msamples/s	Megasamples per second
mV	milliVolts
MΩ	Mega-ohm

ACRONYMS AND ABBREVIATIONS (Cont'd)

N/A	Not Applicable
nA	nanoAmpere
NEC	NEC Electronics, Inc.
NIC	Network Interface Card
NI-RGB	Non-Interlaced Red Green Blue
ns	nanosecond
NTSC	National Television Systems Committee
Ω	Ohm
OHCI	Open Host Controller Interface
OS	Operating System
P/N	Part Number
pA	picoAmpere
PC	Personal Computer
PC	Portable Computer
PCI	Peripheral Component Interconnect
PCMCIA	Personal Computer Memory Card Industry Association
PDIAG-CBLID	Past Diagnostic Cable ID
pF	Picofarad
PHY	Physical Layer
PI	Principle Investigator
PnP	Plug and Play
ppm/ $^{\circ}$ C	parts per million per degree Celsius
PPS	Pulse per Second
PS/2	Mouse or Keyboard Port (Developed by IBM)
PU	Panel Unit
PWR	Power
QWERTY	(Standard Keyboard Layout)
R/W	Read/Write
R2WS	Rack 2 Workstation (same as WS2)
REC	Record
REDRTN	Red Return
RGB	Red, Green, Blue
RIC	Rack Interface Controller
rms	root mean square
ROM	Read-Only Memory
RTN	Return (Signal)
RTS	Request-to-Send
Rx	Receive
Rx-	Receive Low
Rx+	Receive High
RxSHD	Receive Shield

ACRONYMS AND ABBREVIATIONS (Cont'd)

S/W	Software
samples/s	Samples per second
SCSI	Small Computer System Interface
SDRAM	Synchronous Dynamic Random Access Memory
SE	Single-Ended
SGRAM	Synchronous Graphics Random Access Memory
SHD	Shield
SIMD	Single Instruction, Multiple Data
SMP	Symmetric Multiprocessing
Spkr	Speaker
SPW	Serration Pulse Width
SRAM	Static Random Access Memory
SSE	Streaming SIMD Extensions
ST	Serial Time
SVGA	Super Video Graphics Array
Sync	Synchronous
SYNCRTN	Synchronous Return
TBD	To Be Determined
TFT	Thin-Film Transistor
TRIG	Trigger
TS	Time Strobe
TTL	Transistor-Transistor Logic
Tx	Transmit
Tx-	Transmit Low
Tx+	Transmit High
TxSHD	Transmit Shield
Typ.	Typical
US	Ultrasound
USB	Universal Serial Bus
V	Volts
V/ms	Volts per microsecond
VDC	Volts Direct Current
VGA	Video Graphics Array
VPU	Visual Processing Unit
VSYNC	Vertical Synchronization
W	Watts
WS	Workstation
WS2	Workstation 2 (same as R2WS)

1.0 INTRODUCTION

1.1 PURPOSE

This Interface Definition Document (IDD) describes:

1. The interfaces provided by the Human Research Facility (HRF) Rack 2 Workstation (R2WS) P/N: SEG46118400-302.
2. The interfaces between the HRF R2WS and the International Space Station (ISS) and the HRF Racks.

1.2 SCOPE

The R2WS interfaces to be described include: Electrical, data, audio/video (A/V), mechanical, and thermal. No attempt has been made to define the human factors user or software (S/W) interfaces; those tasks are considered out of scope for this document.

2.0 REFERENCE DOCUMENTS

<u>Document Number</u>	<u>Rev.</u>	<u>Document Title</u>
EIA RS-170	A	Monochrome Television Studio Facilities, Electrical Performance Standards, Electronics Industries Association
EIA RS-232		Interface Between Data Terminal Equipment and Data Communications Equipment Employing Serial Binary Data Interchange
EIA RS-422		Electrical Characteristics of Balanced Voltage Digital Interface Circuits
IEEE Standard 802.3/ ISO Detection-8802-3		Carrier Specific Multiple Access with Collision Access Method and Physical Layer Specification
IEEE Standard 1394-1995		IEEE Standard for a High Performance Serial Bus
IRIG-B		Inter Range Instrumentation Group Time Code Standard, Group B
Universal Serial Bus Specification, Rev. 2.0		Universal Serial Bus Specification
S683-34510		Prime Item Development Specification for the Human Research Facility Rack
SIG46117731		Drawing Tree (Rack 2 Workstation)

3.0 RACK 2 WORKSTATION INTERFACES

3.1 ELECTRICAL INTERFACES

3.1.1 HRF R2WS to Rack – Rear Power Connector (J1)

This is a receptacle-type connector, located on the rear panel of the HRF R2WS, with 18-#12 crimp-style pins; it is fabricated per MIL-C-83733. The military specification (MIL-SPEC) part number (P/N) for this connector is M83733/3RA018.

The mate to this connector is a plug-type connector with 18-#12 crimp-style sockets, and a MIL-SPEC P/N of M83733/2RA018.

The HRF R2WS requires +28 VDC from the HRF Rack. The power consumption will be less than 350 Watts (W), average. Power consumption is configuration dependent.

TABLE 3-1. PIN ASSIGNMENT FOR CONNECTOR J1
(REAR POWER CONNECTOR)

REAR POWER CONNECTOR (J1)		
P/N:	M83733/3RA018	
MATE:	M83733/2RA018	
SHELL SIZE:	Small	
WIRE GAUGE:	12	
Pin	Signal	
1	+28 VDC (input to R2WS)	
2	GROUND	
6	+28 VDC (input to R2WS)	
7	GROUND	
12	CHASSIS GROUND	
13	CHASSIS GROUND	

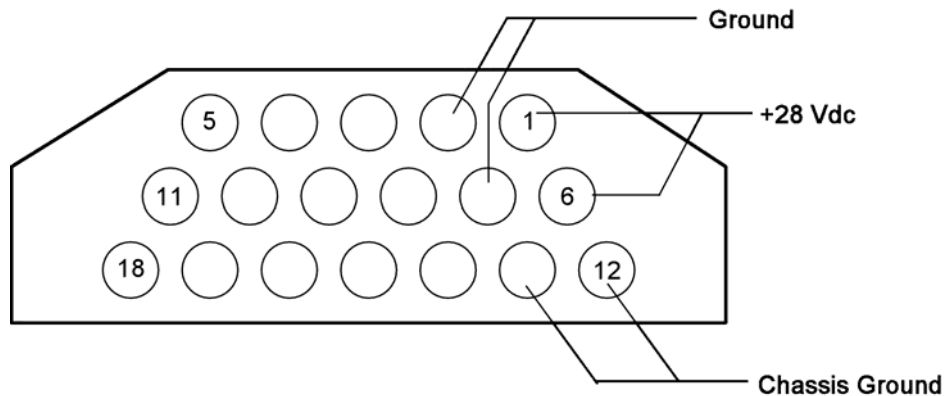

Figure 3-1. Rear Power Connector - Face View

3.1.2 HRF R2WS to Other Payloads – 28 V Power Connector (J11)

This is a receptacle-type connector, shell size 17 with 6-#12 crimp-style sockets; it is fabricated per MIL-C-38999, Series I. The MIL-SPEC P/N for this connector is MS27466T17F6SN.

The mate to this connector is a plug-type connector, shell size 17 with 6-#12 crimp-style pins, and a MIL-SPEC P/N of MS27467T17F6PN.

The front panel 28 V power connector supplies +28 VDC from the Rack through a 10 Ampere (A) circuit breaker. This pass-through 28 V Power is available when its switch/ circuit breaker (Power 28 VDC) is turned on; the HRF R2WS does not have to be powered “ON.” The circuit breaker P/N is M39019/03-249. Wire used is twelve American Wire Gauge (AWG).

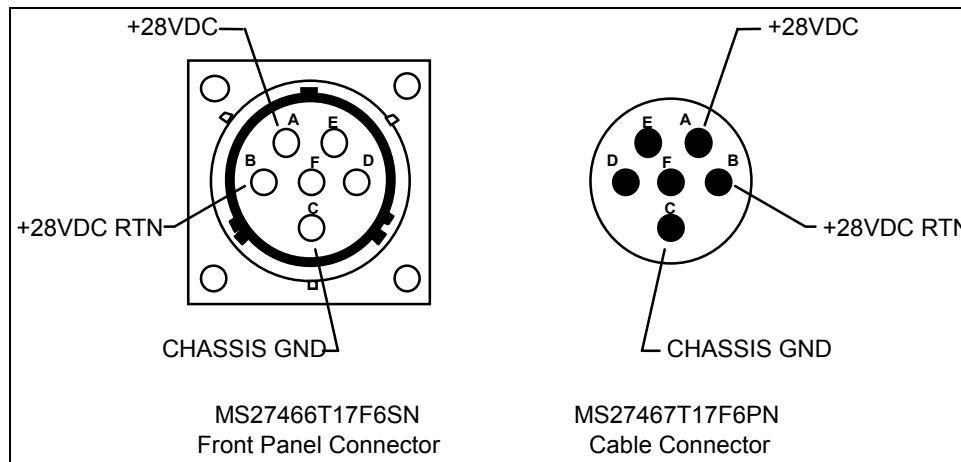

Figure 3-2. 28 V Power Connector Face

3.1.3 Front Panel Power

The Isolation Board provides power through self-resetting fuses: +5 V at 2.5 A, -5 V at 1.1 A, and +12 V at 4 A. Power is available on the front panel on various pins of various connectors. Table 3-2 summarizes the power pins.

TABLE 3-2. FRONT PANEL POWER PINS

Signal	Max. Current (total across all connectors)	Connector	Pin
+5 VDC	2.5 A	J7	31
		J8	52
-5 VDC	1.1 A	J7	33
+12 VDC	4 A	J7	35
		J8	55

3.2 DATA INTERFACES

3.2.1 HRF R2WS to Rack – Rear Data Connector (J2)

This is a receptacle-type connector, located on the rear panel of the HRF R2WS, with 131-#22D crimp-style pins; it is fabricated per MIL-C-83733. The MIL-SPEC P/N for this connector is M83733/3RA131.

The mate to this connector is a plug-type connector with 131-#22D crimp-style sockets, and a MIL-SPEC P/N of M83733/2RA131.

Ethernet, RS-422, and video are available through the rear data connector.

Ethernet to the rear panel is provided by an Intel® 82801EB I/O Controller Hub 5 (ICH5) on the CPU board. Full duplex 10Base-T and 100Base-TX Fast Ethernet modes are supported. The interface is compliant with Institute of Electrical and Electronic Engineers (IEEE) 802.3 and 802.3x Media Access Control (MAC) protocol.

One RS-422 channel is available on the rear panel. This channel is connected to the RS-232 port COM1 of the Central Processing Unit (CPU) board. Conversions between RS-232 and RS-422 are done on the Isolation Board.

One video-out channel is available on the rear data connector. This is a differential RS-170A video output channel from the Isolation Board. The source of this signal would be an external device which outputs a National Television Standards Committee (NTSC) signal into the R2WS via front panel connector J5 (NTSC/Audio).

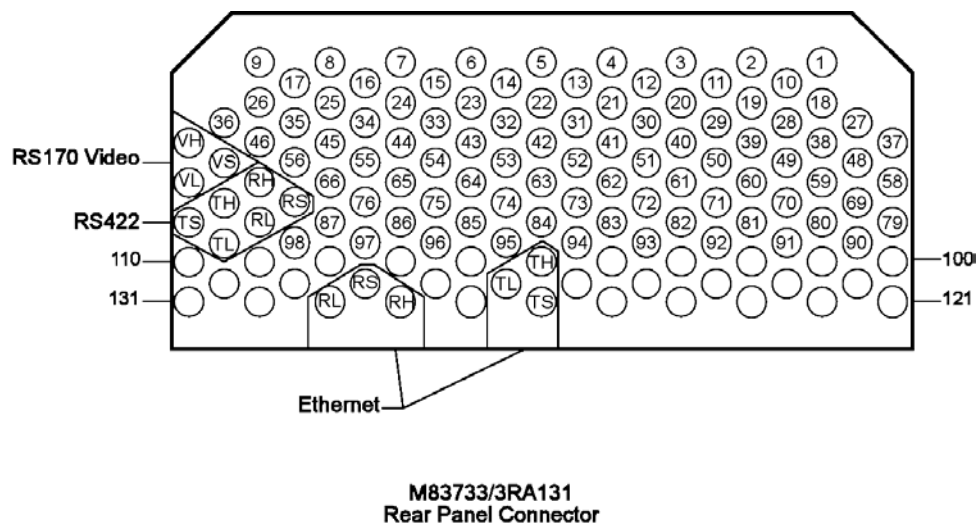
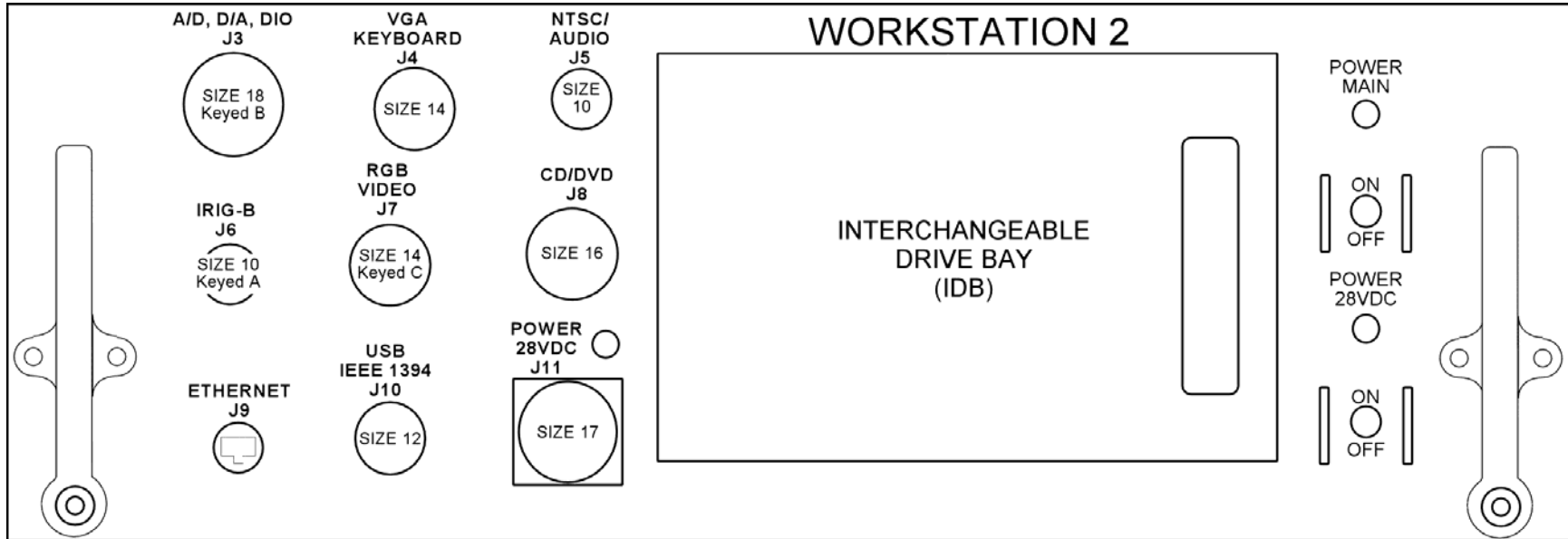

Figure 3-3. Rear Panel Data Connector - Face View

TABLE 3-3. BACK PANEL CONNECTOR PINS USED BY HRF R2WS

REAR DATA CONNECTOR (J2)		
	P/N:	M83733/3RA131
	MATE:	M83733/2RA131
	SHELL SIZE:	small
Pin	Signal	Description
47	Video Out Hi	RS-170 Out High
68	Video Out Lo	RS-170 Out Low
57	SHD	Shield
67	RS422 RX+	RS-422 Receive High (in to R2WS)
88	RS-422 RX-	RS-422 Receive Low (in to R2WS)
77	RS-422 RX SHD	RS-422 Receive Shield
78	RS-422 TX+	RS-422 Transmit High (out from R2WS)
99	RS-422 TX-	RS-422 Transmit Low (out from R2WS)
89	RS-422 TX SHD	RS-422 Transmit Shield
105	Enet TX+	Ethernet Transmit High (out from R2WS)
116	Enet TX-	Ethernet Transmit Low (out from R2WS)
126	Enet TX SHD	Ethernet Transmit Shield
128	Enet RX+	Ethernet Receive High (in to R2WS)
129	Enet RX-	Ethernet Receive Low (in to R2WS)
118	Enet RX SHD	Ethernet Receive Shield
9	CONTINUITY	Connected to each other via a jumper wire
121	CONTINUITY	
24	FAN SPEED (+)	
44	FAN SPEED (-)	



J3	-A/D, D/A, DIO	MS27497T18F35SB (66 #22D sockets)
J4	-VGA/KEYBOARD	MS27497T14F35S (37 #22D sockets)
J5	-NTSC/AUDIO	MS27497T10F35S (13 #22D sockets)
J6	-IRIG-B	MS27497T10F35SA (13 #22D sockets)
J7	-RGB VIDEO	MS27497T14F35SC (37 #22D sockets)
J8	-CD/DVD	MS27497T16F35S (55 #22D sockets)
J9	-ETHERNET	1375188-1 Amp. Inc., RJ45, Jack, Cat 6
J10	-USB/IEEE 1394	MS27497T12F35S (22 #22D sockets)
J11	-POWER 28VDC	MS27466T17F6SN (6 #12 sockets)

Figure 3-4. R2WS Front Panel Diagram

3.2.2 HRF R2WS to Other Payloads

3.2.2.1 Analog-to-Digital (A/D), Digital-to-Analog (D/A), Digital Input/Output (DIO) Connector (J3)

This is a receptacle-type connector, shell size 18, keyed “B,” with 66-#22D crimp-style sockets; it is fabricated per MIL-C-38999, Series II. The MIL-SPEC P/N for this connector is MS27497T18F35SB.

The mate to this connector is a plug-type connector, shell size 18, keyed “B,” with 66-#22D crimp-style pins, and a MIL-SPEC P/N of MS27484T18F35PB.

This interface provides:

- Eight differential channels of A/D input with 16-bit resolution
- Two channels of D/A output with 16-bit resolution
- Two differential Digital Output Channels
- Two differential Digital Input Channels
- One differential pacer clock output

The analog input signals pass through an anti-aliasing low-pass filter board between the front panel and the A/D board (the data acquisition board). The anti-aliasing board provides 8-pole elliptic filters and amplifiers for the eight analog input channels. The gain on each channel is independently software selectable for 0.5, 1, 2, 5, 10, 20, 50, 100, 200, 500, or 1000 for an input range of 5m V to 10 V. The cutoff frequency of the filters can be programmed for a range of frequencies from 10 Hertz (Hz) to 100 kiloHertz (kHz). Each two-channel pair (channels 0 and 1, 2 and 3, 4 and 5, 6 and 7 are pairs) can operate with a different cutoff frequency. The signal is then passed to the data acquisition board (A/D board). A pacer clock signal from the anti-aliasing board is available at this connector; this signal passes through the Isolation Board.

The analog output, digital input, and digital output are from the A/D board and pass through the Isolation Board. For DIO, bits 0 and 1 of Port A are for output; bits 0 and 1 of Port B are for input. The remaining bits are not wired. This discrete input will work with single ended Transistor-Transistor Logic (TTL), and Complementary Metal Oxide Semiconductor (CMOS) signals, as well as differential TTL or RS-422 signals. Any signal less than 1.24 V is considered a low, and any signal greater than 1.24 V is considered a high level.

- TTL signals should be less than .5 V for low, and greater than 2.5 V for high.
- CMOS signals should be less than .25 V for a low, and greater than 4.75 V for a high.
- RS-422 signals should be less than -2.0 V for a low, and greater than +2.0 V for a high.

Shield pins are tied internally to chassis at the front panel.

Interface specifications are shown in Table 3-4. Parameters of the Isolation Board are noted.

NOTE: The anti-aliasing filter causes a 180-degree phase shift and signals appear inverted. To correct this, signals may be connected such that positive signals are connected to negative (-) pins and negative signals are connected to positive (+) pins.

TABLE 3-4. INTERFACE SPECIFICATIONS FOR
CONNECTOR J3 (A/D, D/A, DIO)

Analog Input (directly into Anti-Aliasing Board)		
Common-mode rejection	75 dB min., 86 dB typical (gain = 1)	
Common-mode voltage	± 10 V max.	
Input voltage (gain = 0.5)	± 10 V max.	
Input protection	± 50 V max.	
Input impedance	2MΩ each side to analog ground	
Input bias current	± 2 pA typ., ± 100 pA max.	
Input offset current	± 1 pA typ., ± 100 pA max.	
Amplifier bandwidth	Gain = 0.5 to 5	1.2 MHz typ.
	Gain = 10 - 100	600 ksamples/s typ.
	Gain = 200 - 1000	250 ksamples/s typ.
Amplifier slew rate	9/gain V/ms typical	
Elliptical Filter (software selectable)		
Cutoff frequency	Passband performance	Stopband rejection
10 Hz - 100 kHz (1 Hz opt.)	+0.4 dB - 0.2 dB max. to 0.85 cutoff	
10 Hz - 50 kHz (1 Hz opt.)	Group delay ±1% max to cutoff; 1 dB droop typical at 0.75 cutoff, low-freq. Gain +0.4 dB-0.2 dB max	90 dB typical
Analog Inputs (A/D Board)	Number of channels	8 differential
	Resolution	16 bits
	Channel-gain list	1024 locations
	Input FIFO size	1024 locations
	Input gains	1, 2, 4, 8
	Input range	Bipolar: ± 10, ± 5, ± 2.5, ± 1.25 V Unipolar: 0-10, 5, 2.5, 1.25 V
	Drift	Zero: ± 30 μV + (+20 μV*Gain)/°C Gain: ± 30 ppm/°C
	Input impedance	100 MΩ, 10 pF, Off 100 MΩ, 100 pF, On
	Input bias current (includes mux and amplifier)	± 20 nA
	Common mode voltage	± 11 V maximum (operational)
	Maximum input voltage	± 40 V maximum (protection)
	Channel acquisition time (max)	1 μs
	A/D conversion time	4 μs
	DC accuracy	
	Nonlinearity (integral)(max)	± 4.0 LSB
	Differential nonlinearity (max)	± 1.2 LSB (no missing codes to 15 bits)
	System noise	0.3 LSB rms
	Channel-to-channel offset	± 40.0 μV
	AC accuracy	
	Effective Number of Bits (ENOB)	14.0
	Total harmonic distortion	-90 dB typical
Channel crosstalk	-80 dB at 1 kHz	

TABLE 3-4. INTERFACE SPECIFICATIONS FOR
CONNECTOR J3 (A/D, D/A, DIO) (Cont'd)

	Clocking and Triggering for A/D	Number counter/timer channels: 2 Resolution: 24-bit
	Maximum A/D pacer clock	
	Single analog input throughput	250 ksamples/s at 0.01% accuracy
	Multiple analog input throughput	150 ksamples/s at 0.01% accuracy
	Multiple analog input throughput	250 ksamples/s at 0.05% accuracy
	Single digital input channel	3 Msamples/s
	Minimum A/D pacer clock throughput	1.2 samples/s
	External A/D sample clock	
	Minimum pulse width	100 ns (high); 100 ns (low)
	Maximum frequency (analog inputs)	250 kHz
	Maximum frequency (digital inputs only)	3 MHz
	External digital (TTL) trigger	
	High-level input voltage	2.0 V minimum
	Low-level input voltage	0.8 V maximum
	Minimum pulse width	100 ns (high); 100 ns (low)
Analog Outputs (A/D Board)	Number of channels	2 (voltage output)
	Resolution	16-bit
	Output Voltage (Isolation Board)	±5 V min. Line-to-GND
	Differential Output Voltage (Isolation Board)	±5 V Line-to-Line
	Typical throughput	10 ksamples/s
	Error (Isolation Board)	.7 to 2%
	Current output (Isolation Board)	± 9 mA minimum
	Output impedance (Isolation Board)	50 Ω ± 5 Ω (typical)
	Capacitive drive capability (Isolation Board)	10 μF (no oscillators)
	Nonlinearity (integral)	± 1.0 LSB
	Differential nonlinearity	± 0.5 LSB (monotonic)
	Protection	Short circuit to Analog Common
	Power-on voltage	0 V ± 10 mV
	Setting time to 0.01% of FSR	50 μs, 20 V step; 10.0 μs, 100 mV step
	Slew rate	2 V/μs
DIO (Isolation Board)	Digital Input	
	Low-level input voltage (line-to-line)	-5.2 V to +1.25 V
	High-level input voltage (line-to-line)	+1.25 V to +5.2 V
	Impedance (line-to-GND)	> 12 kΩ
	Impedance (line-to-line)	> 10 kΩ
	ESD protection	
	Human Body Model	± 15 kV
	Contact Discharge	± 8 kV IEC10004.2
	Air Gap Discharge	± 15 kV IEC10004.2
	Circuit damage protection	400 W peak
	Digital Output	
	Maximum load (line-to-line)	100 Ω
	Differential output voltage	1.5 V to 6 V

TABLE 3-5. PIN ASSIGNMENTS FOR CONNECTOR J3 (A/D, D/A, DIO)

(J3) A/D, D/A, DIO: 8 DIFFERENTIAL ANALOG INPUT CHANNELS, 2 DIFFERENTIAL ANALOG OUTPUT CHANNELS, 2 DIGITAL INPUT (differential with RS422 drivers, or single-ended), 2 DIGITAL OUTPUT (differential with RS422 drivers)			
P/N:		MS27497T18F35SB (KEYED B)	
MATE:		MS27484T18F35PB	
SHELL SIZE:		18	
Pin	Signal	Corresponding Board Signal	
4	IN 0+	IN 0 HI	Analog hi input channel 0
5	IN 0-	IN 0 LO	Analog lo input channel 0
1	SHD		not connected to board
6	IN 1+	IN 1 HI	Analog hi input channel 1
7	IN 1-	IN 1 LO	Analog lo input channel 1
2	SHD		not connected to board
8	IN 2+	IN 2 HI	Analog hi input channel 2
9	IN 2-	IN 2 LO	Analog lo input channel 2
3	SHD		not connected to board
10	IN 3+	IN 3 HI	Analog hi input channel 3
11	IN 3-	IN 3 LO	Analog lo input channel 3
18	SHD		not connected to board
12	IN 4+	IN 4 HI	Analog hi input channel 4
13	IN 4-	IN 4 LO	Analog lo input channel 4
20	SHD		not connected to board
14	IN 5+	IN 5 HI	Analog hi input channel 5
15	IN 5-	IN 5 LO	Analog lo input channel 5
22	SHD		not connected to board
25	IN 6+	IN 6 HI	Analog hi input channel 6
26	IN 6-	IN 6 LO	Analog lo input channel 6
17	SHD		not connected to board
27	IN 7+	IN 7 HI	Analog hi input channel 7
28	IN 7-	IN 7 LO	Analog lo input channel 7
19	SHD		not connected to board
29	ANLG OUT 0+	DAC 0+	From A/D board, converted to differential
30	ANLG OUT 0-	DAC 0-	
21	SHD		
31	ANLG OUT 1+	DAC 1+	From A/D board, converted to differential
32	ANLG OUT 1-	DAC 1-	
23	SHD		
16	PACERCLK+		From anti-alias, converted to differential on isolation board
24	PACERCLK-		From anti-alias, converted to differential on isolation board
33	SHD		
47	DIG OUT0+		From A/D board, Port A Bit 0
48	DIG OUT0-		Digital GND
55	SHD		
49	DIG OUT1+		From A/D board, Port A Bit 1
50	DIG OUT1-		Digital GND
57	SHD		
65	DIG IN 0+		To A/D board, Port B Bit 0
66	DIG IN 0-		Digital GND
62	DIG IN 1+		To A/D board, Port B Bit 1

TABLE 3-5. PIN ASSIGNMENTS FOR CONNECTOR J3 (A/D, D/A, DIO) (Cont'd)

(J3) A/D, D/A, DIO: 8 DIFFERENTIAL ANALOG INPUT CHANNELS, 2 DIFFERENTIAL ANALOG OUTPUT CHANNELS, 2 DIGITAL INPUT (differential with RS422 drivers, or single-ended), 2 DIGITAL OUTPUT (differential with RS422 drivers)		
P/N: MS27497T18F35SB (KEYED B)		
MATE: MS27484T18F35PB		
SHELL SIZE: 18		
Pin	Signal	Corresponding Board Signal
63	DIG IN 1-	Digital GND
56	SHD	
34	no connect	
35	no connect	
36	no connect	
37	no connect	
38	no connect	
39	no connect	
40	no connect	
41	no connect	
42	no connect	
43	no connect	
44	no connect	
45	no connect	
46	no connect	
51	no connect	
52	no connect	
53	no connect	
54	no connect	
58	no connect	
59	no connect	
60	no connect	
61	no connect	
64	no connect	

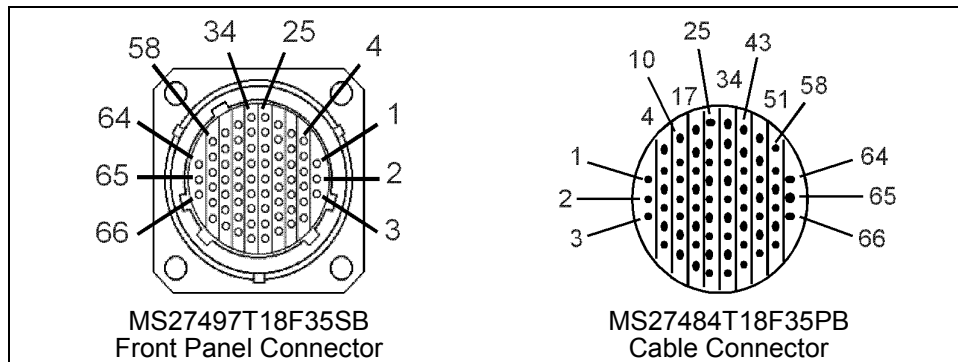

Figure 3-5. A/D, D/A, DIO Connector Face

3.2.2.2 VGA/Keyboard Connector (J4)

This is a plug-type connector, shell size 14, with 37-#22D crimp-style sockets; it is fabricated per MIL-C-38999, Series II. The MIL-SPEC P/N for this connector is MS27497T14F35S.

The mate to this connector is a receptacle-type connector, shell size 14, with 37-#22D crimp-style pins, and a MIL-SPEC P/N of MS27484T14F35P.

Video Graphics Array (VGA) output is from the VGA output of the video card. Standard multi-sync monitors are supported at resolutions of 640 by 480 up to 2048 by 1536 pixels, at 8-bit, 16-bit, and true color.

A single PS/2 port on the CPU board provides keyboard and mouse signals, however, only the keyboard signal is wired to the front panel; the same signal was split into a “Y” configuration for two sets of pins on the front panel. Also included are signals from COM2 of the CPU board, including handshaking, for pointing devices that use an RS-232 serial interface.

TABLE 3-6. PIN ASSIGNMENTS FOR CONNECTOR J4 (VGA/KEYBOARD)

VGA/Keyboard (J4)					
VGA—pins 20, 21, 25, 28-37			PS/2 Keyboard—pins 15-18		
P/N: MS27497T14F35S			RS-232—pins 2-6, 22, 24, 32		
MATE: MS27484T14F35P					
SHELL SIZE: 14					
WIRE GAUGE: 26					
Pin	Signal	Pin	Signal	Pin	Signal
1	no connect	13	PS/2 PWR (+5 V)	25	GND (SYNCRTN)
2	232DSR	14	PS/2 GND	26	no connect
3	232RX	15	PS/2 DATA	27	no connect
4	232RTS	16	PS/2 CLK	28	GND (BLURTN)
5	232CTS	17	PS/2 PWR (+5 V)	29	GND (GRNRTN)
6	232TX	18	PS/2 GND	30	GND (REDRTN)
7	no connect	19	no connect	31	GND
8	no connect	20	VSYNC (OUT)	32	232GND
9	no connect	21	HSYNC (OUT)	33	Monitor ID 2
10	no connect	22	232DTR	34	BLU
11	PS/2 DATA	23	no connect	35	Monitor ID 0
12	PS/2 CLK	24	232DCD	36	GRN
—		—		37	RED

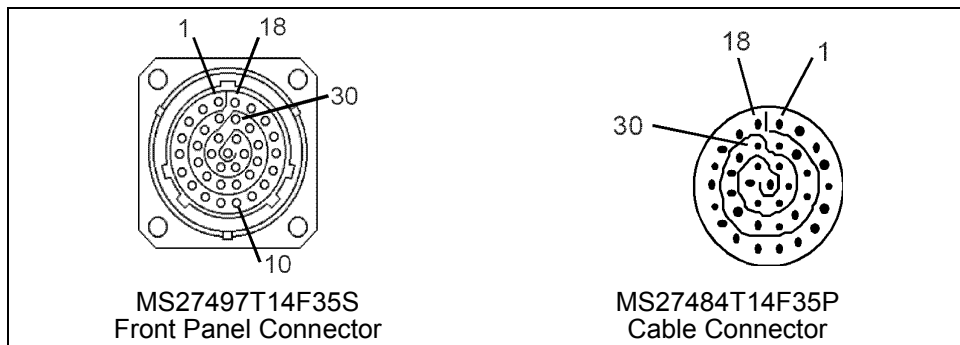

Figure 3-6. VGA/Keyboard Connector Face

3.2.2.3 IRIG-B Connector (J6)

This is a receptacle-type connector, shell size 10, keyed “A,” with 13-#22D crimp-style sockets; it is fabricated per MIL-C-38999, Series II. The MIL-SPEC P/N for this connector is MS27497T10F35SA.

The mate to this connector is a plug-type connector, shell size 10, keyed “A,” with 13-#22D crimp-style pins, and a MIL-SPEC P/N of MS27484T10F35PA.

This interface allows a clock signal and trigger signal to be input to the data acquisition board. Signals pass through the Isolation board for differential-to-single-ended conversion.

TABLE 3-7. PIN ASSIGNMENTS FOR CONNECTOR J6 (IRIG-B)

IRIG-B CONNECTOR (J6)		
Pins 1 - 40: no connect		
P/N:		MS27497T10F35SA (KEYED A)
MATE:		MS27484T10F35PA
SHELL SIZE:		10
Pin	Signal	Notes
1	DAS-CLKHI	Data Acquisition System Clk High (input to R2WS)
2	DAS-CLKLO	Data Acquisition System Clk Low
3	DAS-TRIGHI	Data Acquisition System Trigger High (input to R2WS)
4	no connect	not used
5	no connect	not used
6	DAS-TRIGLO	Data Acquisition System Trigger Low
7	no connect	not used
8	no connect	not used
9	DAS-SHD	Data Acquisition System Shield
10	no connect	
11	DAS-CLKSHD	Data Acquisition System Clock Shield
12	STSHD	not used
13	TSSHD	not used

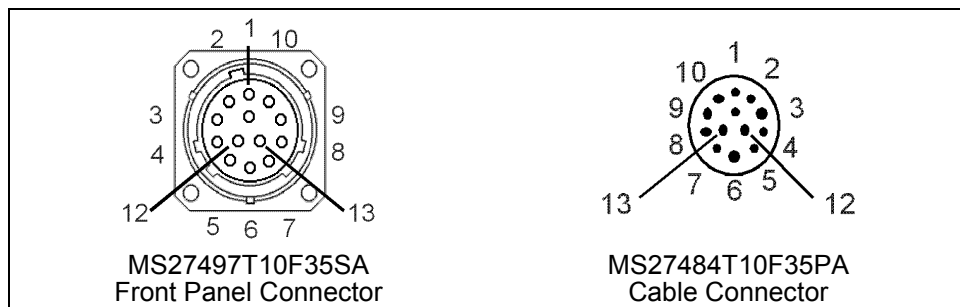

Figure 3-7. IRIG-B Connector Face

3.2.2.4 Compact Disc/Digital Versatile Disc (CD/DVD) (J8)

This is a receptacle-type connector, shell size 16, with 55-#22D crimp-style sockets; it is fabricated per MIL-C-38999, Series II. The MIL-SPEC P/N for this connector is MS27497T16F35S.

The mate to this connector is a plug-type connector, shell size 16, with 55-#22D crimp-style pins, and a MIL-SPEC P/N of MS27484T16F35P.

The pins for the Integrated Drive Electronics (IDE) interface is preserved from the previous workstation configuration, but are now not connected to anything internally. Instead, connectivity is via a USB interface, provided by a USB port on the CPU board. The audio is connected to the sound interface of the CPU Board.

The Isolation Board provides power to this connector through self-resetting fuses: +5 V at 2.5 A and +12 V at 4 A. These power signals are also on connector J7 (RGB VIDEO) in parallel.

TABLE 3-8. PIN ASSIGNMENTS FOR CONNECTOR J8 (CD/DVD)

CD/DVD (J8)		Pins 1-42: no connect			
P/N:		MS27497T16F35S			
MATE:		MS27484T16F35P			
SHELL SIZE:		16			
Pin	Signal	Pin	Signal	Pin	Signal
1	no connect	20	no connect	39	no connect
2	no connect	21	no connect	40	no connect
3	no connect	22	no connect	41	no connect
4	no connect	23	no connect	42	no connect
5	no connect	24	no connect	43	CD LEFT
6	no connect	25	no connect	44	CD GND
7	no connect	26	no connect	45	CD GND
8	no connect	27	no connect	46	CD RIGHT
9	no connect	28	no connect	47	+5 VDC (2.5 A max.)
10	no connect	29	no connect	48	USB +5 VDC
11	no connect	30	no connect	49	USB-
12	no connect	31	no connect	50	USB+
13	no connect	32	no connect	51	USB GND
14	no connect	33	no connect	52	Shield
15	no connect	34	no connect	53	GND
16	no connect	35	no connect	54	GND
17	no connect	36	no connect	55	+12 VDC (4 A max.)
18	no connect	37	no connect	-	
19	no connect	38	no connect	-	

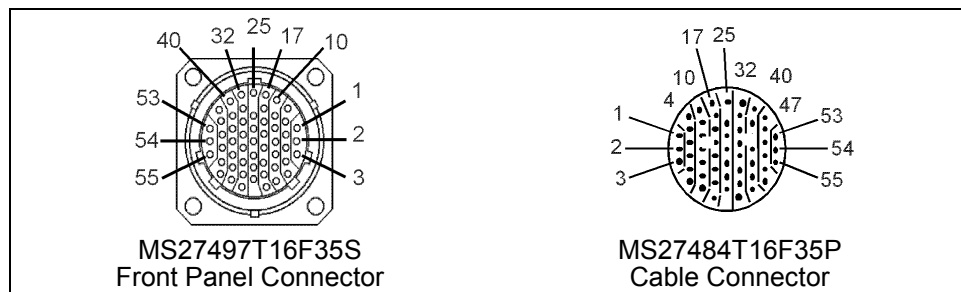

Figure 3-8. CD/DVD Connector Face

3.2.2.5 Ethernet Connector (J9)

This is an RJ45 type modular connector receptacle with eight contacts. It satisfies TIA/EIA-568-B, 2-1 and IEC 60603-7-4 requirements for category 6/Class E. Its P/N is 1375188-1 by AMP, Harrisburg, PA.

The mate to this connector is an RJ45-type modular plug connector with eight contacts. A possible P/N is 5-1375204-3 by AMP, Harrisburg, PA.

This Ethernet capability is provided by an Intel® i82547EI Gigabit Ethernet Controller resident on the CPU board. This Ethernet can be operated at 1000 BASE-T, 100BASE-TX, or 10BASE-T full duplex Ethernet. The interface is compliant with IEEE 802.3.

The Ethernet Connector Saver, P/N: SEG46117757-30x, should be used with this interface to avoid excessive wear and tear of this connector. The adapter has the same modular jack and is constructed using category 6 cable. The adapter cable should be mated to the front panel connector and be allowed to remain there unless situation warrants its removal.

TABLE 3-9. PIN ASSIGNMENTS FOR CONNECTOR J9 (ETHERNET)

ETHERNET CONNECTOR (J9)		
P/N:		MS27497T8F35S
MATE:		MS27484T8F35P
SHELL SIZE:		8
Pin	Signal	Function
1	TX +	Transmit High (out from R2WS)
2	TX -	Transmit Low (out from R2WS)
3	RX +	Receive High (in to R2WS)
4	GND	Ground
5	GND	Ground
6	RX -	Receive Low (in to R2WS)
7	GND	Ground
8	GND	Ground

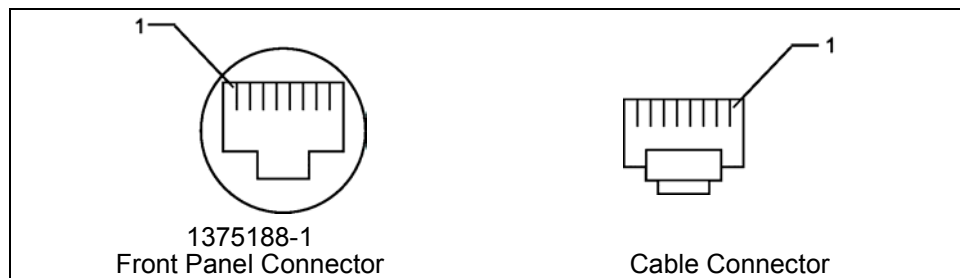

Figure 3-9. Ethernet Connector Face

3.2.2.6 UNIVERSAL SERIAL BUS (USB)/IEEE 1394 Connector (J10)

This is a plug-type connector, shell size 12, with 22-#22D crimp-style sockets; it is fabricated per MIL-C-38999, Series II. The MIL-SPEC P/N for this connector is MS27497T12F35S.

The mate to this connector is a receptacle-type connector, shell size 12, with 22-#22D crimp-style pins, and a MIL-SPEC P/N of MS27484T12F35P.

Two USB channels and two IEEE 1394 channels are routed to the front panel connector J10. The IEEE 1394 interfaces are provided by a controller board. Maximum power is 15 W total for the IEEE 1394 connector.

The USB interfaces are provided by the CPU Board and are USB 2.0/1.1 compliant.

For IEEE 1394, the mating cable should be built such that the pairs are crossed – connect Pair A of R2WS to Pair B of peripheral device, and connect Pair B of R2WS to Pair A of peripheral device. Similarly, connect Pair C of R2WS to Pair D of peripheral device; connect Pair D of R2WS to Pair C of peripheral device. IEEE 1394 shield must be connected to pin ten for reliable operation.

TABLE 3-10. PIN ASSIGNMENTS FOR CONNECTOR J10 (USB/IEEE 1394)

USB/IEEE 1394 (J10)			
P/N:		MS27497T1235S	
MATE:		MS27484T1235P	
SHELL SIZE:		12	
Pin	Signal	Pin	Signal
1	USB0 PWR	12	IEEE 1394 GND
2	USB0+	13	IEEE 1394 A+
3	USB0-	14	IEEE 1394 A-
4	USB0 GND	15	IEEE 1394 B+
5	USB1PWR	16	IEEE 1394 B-
6	USB1+	17	IEEE 1394 PWR
7	USB1-	18	IEEE 1394 GND
8	USB1GND	19	IEEE 1394 C+
9	SHIELD (USB, tied to chassis)	20	IEEE 1394 C-
10	SHIELD (IEEE 1394)	21	IEEE 1394 D+
11	IEEE 1394 PWR	22	IEEE 1394 D-

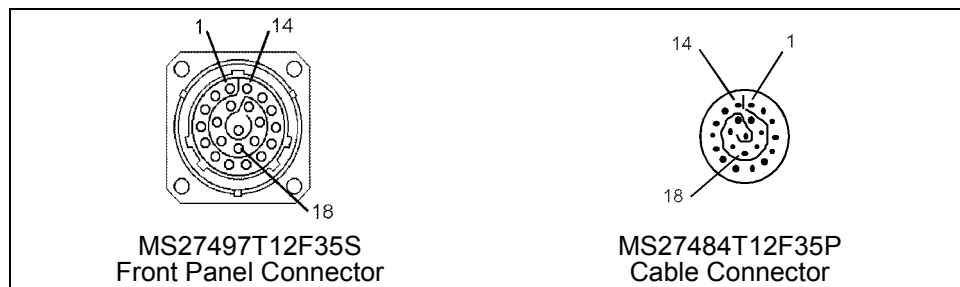

Figure 3-10. USB/IEEE 1394 Connector Face

3.3 AUDIO/VIDEO INTERFACES

3.3.1 National Television Systems Committee/Audio Connector (J5)

This is a plug-type connector, shell size 10, with 13-#22D crimp-style sockets; it is fabricated per MIL-C-38999, Series II. The MIL-SPEC P/N for this connector is MS27497T10F35S.

The mate to this connector is a receptacle-type connector, shell size 10, with 13-#22D crimp-style pins, and a MIL-SPEC P/N of MS27484T10F35P.

Audio is provided by a Realtek® ALC202A audio CODEC on the CPU Board. It is compliant with AC '97 rev. 2.2 specifications. This CODEC has 18-bit Analog-to-Digital Converter (ADC) and 20-bit DAC resolution; output can drive 50 mW/8Ω; mic input has +30 dB boost preamplifier. All audio signals are single-ended.

Video is for NTSC video input only. The NTSC signal is converted to RS-170A on the Isolation Board and then passed through to the rear data connector.

Shield(s) on mating cable should be terminated to connector backshell for electrical continuity with the chassis.

TABLE 3-11. PIN ASSIGNMENTS FOR CONNECTOR J5
(NTSC/AUDIO CONNECTOR)

NTSC/AUDIO CONNECTOR (J5)		
P/N:		MS27497T10F35S
MATE:		MS27484T10F35P
SHELL SIZE:		10
Pin	Signal	Notes
1	Left Out	
2	Left GND	
3	no connect	
4	Right Out	
5	Right GND	
6	no connect	
7	Mic In	
8	Mic/Line GND	
9	no connect	
10	Line In	
11	NTSC IN	
12	NTSC GND	
13	NTSC SHD	



Figure 3-11. NTSC/Audio Connector Face

3.3.2 RGB Connector (J7)

This is a plug-type connector, shell size 14, keyed “C,” with 37-#22D crimp-style sockets; it is fabricated per MIL-C-38999, Series II. The MIL-SPEC P/N for this connector is MS27497T14F35SC.

The mate to this connector is a receptacle-type connector, shell size 14, keyed “C,” with 37-#22D crimp-style pins, and a MIL-SPEC P/N of MS27484T14F35PC.

There are two RGB output channels on the front panel. The RGB outputs are from the AGP video card. The left-eye RGB signal is the same signal to VGA pins of connector J4 (VGA/Keyboard) minus the monitor identification signals; it is from the “VGA” output of the video card. The right-eye output is from the “DVI” output of the video card. Dual-screen output is set using software. For dual-screen applications, both screens must be connected and powered “ON” prior to boot-up in order for the driver to load.

Power from the main power supply is routed to this connector through self-resetting fuses on the Isolation Board: +5 V at 2.5 A, -5 V at 1.1 A, and +12 V at 4 A. These power signals are also on connector J8 (CD/DVD) in parallel.

TABLE 3-12. PIN ASSIGNMENTS FOR CONNECTOR J7 (RGB VIDEO)

RGB VIDEO (J7)					
P/N:		MS27497T14F35SC (Keyed C)			
MATE:		MS27484T14F35PC			
SHELL SIZE:		14			
WIRE GAUGE:		26			
Pin	Signal	Pin	Signal	Pin	Signal
1	REDLFOUT	13	GRNRTOU	25	no connect
2	GND	14	GND	26	no connect
3	GRNLFOUT	15	BLURTOU	27	no connect
4	GND	16	GND	28	no connect
5	BLULFOUT	17	HSRTOU	29	no connect
6	GND	18	GND	30	no connect
7	HSLFOUT	19	VSRTOUT	31	+5 VDC (2.5 A max.)(output)
8	GND	20	GND	32	GND
9	VSLFOUT	21	no connect	33	-5 VDC (1.1 A max.)(output)
10	GND	22	no connect	34	GND
11	REDRTOU	23	no connect	35	+12 VDC (4 A max.)(output)
12	GND	24	no connect	36	GND
-		-		37	SHIELD

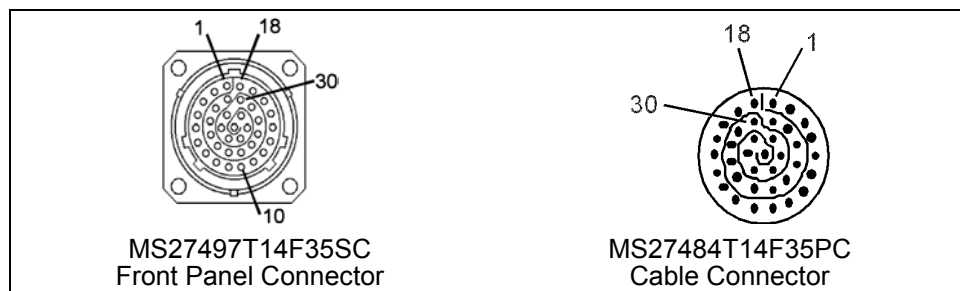

Figure 3-12. RGB Connector Face

3.4 HUMAN INTERFACES

3.4.1 Keyboard

The keyboard is stowed in the HRF Rack and can be removed and attached to the Rack Seat Track using a Multi-use Bracket Assembly, P/N SEG33107631-301, with a Desktop Plate Assembly, P/N SED33108703-302. The keyboard will be fastened to this plate with hook-and-loop fasteners. The keyboard is full size, has full-travel keys, 101-key functionality, supports “QWERTY” input, and includes a trackball. The keyboard is interfaced to the HRF R2WS computer drawer by a cable to connector J4 (VGA/Keyboard) and will receive power from the computer drawer. The keyboard has one connector; it is a 9-pin male D-subminiature located on the rear panel of the keyboard.

The keyboard weighs 4.2 pounds (lbs) and its dimensions are 16.9 x 8.6 x 1.90 inches (in.). The keyboard functionality is compatible with either IBM PC AT interface or PS/2. The trackball functionality is compatible with RS-232 interface.

TABLE 3.4.1-1. KEYBOARD CONNECTOR PINOUT

Pin	Signal	Pin	Signal
1	Signal Return	6	Keyboard Clock
2	Signal Return	7	Trackball Transmit
3	+5 Vdc	8	+5 Vdc
4	Keyboard Data	9	Chassis Ground (Safety)
5	Trackball RTS	Shell	Chassis Ground (Primary)

3.4.2 Display

The HRF Flat Screen Display (FSD) is a flat-panel thin-film transistor (TFT) active matrix display designed to work with the HRF WS, HRF R2WS, and HRF Ultrasound (US) systems. The FSD is stowed in an HRF Rack and can be removed and attached to the Rack Seat Track using a Multi-use Bracket Assembly, P/N SEG33107631-301, with plate assembly, P/N SED33108703-302. The FSD will be fastened using hook-and-loop fasteners.

The FSD has the following properties:

Display Size:	16.1-in. diagonal viewable area
Resolution:	640x480 pixels up to 1280x1024 pixels, 250000 or greater colors at 1280x1024 resolution; can accept and display 256 levels of gray (8-bit grayscale).
Viewing Angles:	65 degrees left, 65 degrees right, 20 degrees downward, and 40 degrees upward (minimum).
Input:	Red, blue, green, vertical sync and horizontal sync and corresponding returns (24-bit color: 8-bit red, 8-bit green, 8-bit blue)

Refresh Rate:	60 Hz
Contrast Ratio:	100:1
Power Requirements:	28 ± 4 VDC, <126 W
Operating Temperature:	(nominal) 75 °F ± 20 °F
Weight:	19.66 lbs
Volume:	18 x 14 x 4.75 in.

US-specific properties of the FSD are indicated in Table 3-13.

TABLE 3-13. HRF ULTRASOUND VIDEO REQUIREMENTS

Requirement:	Non-Interlaced RGB	Interlaced RGB
Vertical Sync	6 lines	3 lines
Vertical Front Porch, even field	N/A	7 lines
Vertical Front Porch, odd field	15	7.5 lines
Vertical Back Porch, even field	28 lines	14.5 lines
Vertical Back Porch, odd field	28 lines	14 lines
Horizontal Frequency	31.468 kHz	15.734 kHz
Horizontal Sync Period	2.61 μs	4.70 μs
Front Porch	.46 μs	1.80 μs
Back Porch	2.63 μs	4.90 μs
White Level	714 mV	714 mV
Black Level	55 mV	55 mV
Blank Level	0	0
Sync Level	2.4 V (TTL)	2.4 V (TTL)
Blanking Period	5.70 μs	11.40 μs
Pixel Clock Frequency	24.5454 MHz	12.2727 MHz
Active Line Time	26.10 μs	52.15 μs
Line Time	31.80 μs	63.55 μs
Number of Lines/Frame	525 lines	525 lines
Frame Rate	60 FPS	30 FPS
Serration Pulse Width (SPW)	2.61 μs	N/A
Vertical Active Period	476 lines	238 lines
Number of Lines per Field	525 lines	262.5 lines

Located on the right panel of the FSD are three input connectors – labeled “Ultrasound,” “Workstation,” and “Power” – a System Power switch, and a mode switch labeled “Ultrasound Playback,” “US Live,” and “Workstation.” When used to display video from the R2WS, set the mode switch to “Workstation.”

HRF FSD “Workstation” connector:

This is a plug-type connector, shell size 10, with 13-#22D crimp-style pins; it is fabricated per MIL-C-38999, Series II. The MIL-SPEC P/N for this connector is MS27497T10F35P.

The mate to this connector is a receptacle-type connector, shell size 10, with 13-#22D crimp-style sockets, and a MIL-SPEC P/N of MS27484T10F35S.

TABLE 3-14. PIN ASSIGNMENTS FOR HRF FSD WORKSTATION CONNECTOR

HRF FSD "WORKSTATION" CONNECTOR			
P/N:		MS27497T10F35P	
MATE:		MS27484T10F35S	
SHELL SIZE:		10	
Pin	Signal	Pin	Signal
1	Red	7	Hsync
2	Red Return	8	Hsync Return
3	Green	9	Vsync
4	Green Return	10	Vsync Return
5	Blue	11	Shield
6	Blue Return	12	no connect
		13	no connect

HRF FSD "Ultrasound" connector:

This is a plug-type connector, shell size 12, with 22-#22D crimp-style pins; it is fabricated per MIL-C-38999, Series II. The MIL-SPEC P/N for this connector is MS27497T12F35P.

The mate to this connector is a receptacle-type connector, shell size 12, with 22-#22D crimp-style sockets, and a MIL-SPEC P/N of MS27484T12F35S.

TABLE 3-15. PIN ASSIGNMENTS FOR HRF FSD ULTRASOUND (US) CONNECTOR

HRF FSD "ULTRASOUND" CONNECTOR			
P/N:		MS27497T12F35P	
MATE:		MS27484T12F35S	
SHELL SIZE:		12	
Pin	Signal	Pin	Signal
1	Red	12	EOT Return
2	Red Return	13	REC Return
3	Green	14	no connect
4	Green Return	15	no connect
5	Blue	16	no connect
6	Blue Return	17	no connect
7	Hsync	18	no connect
8	Hsync Return	19	no connect
9	Vsync	20	no connect
10	Vsync Return	21	no connect
11	5 VDC	22	no connect

HRF FSD “Power” connector:

This is a receptacle-type connector, shell size 17 with six #12 crimp-style pins; it is fabricated per MIL-C-38999, Series I. The MIL-SPEC P/N for this connector is MS27466T17F35PN.

The mate to this connector is a plug-type connector, shell size 17 with six #12 crimp-style sockets, and a MIL-SPEC P/N of MS27467T17F35SN.

TABLE 3-16. PIN ASSIGNMENTS FOR HRF FSD
POWER CONNECTOR

HRF FSD POWER CONNECTOR			
P/N:		MS27466T17F35PN	
MATE:		MS27467T17F35SN	
SHELL SIZE:		17	
Pin	Signal	Pin	Signal
A	28 VDC (input to FSD)	D	no connect
B	28 VDC RETURN	E	no connect
C	Chassis GND	F	no connect

3.4.3 Light-Emitting Diode

The HRF R2WS has three green LEDs on the front panel. The LED P/N is JTXM19500/52102. The “Power Main” LED will be lit when the HRF R2WS is powered “ON.” The “28 VDC” LEDs, one located by the switch and the other located by the 28 VDC Power connector, will be lit when the switch for the pass-through 28 V power is “ON.”

3.5 MECHANICAL INTERFACES

Structural support during launch and re-entry will be provided by the HRF Rack. The HRF R2WS has one slide assembly on each side panel of the active drawer. The slide assembly, which is attached to the active drawer of the HRF R2WS, interfaces with the slide guide assembly mounted in the rack. Due to the modular nature of the HRF rack, the slide guide assemblies are positioned at 4-PU intervals.

3.6 THERMAL INTERFACES

The HRF R2WS active drawer uses internal fans and the HRF Rack Avionic Air Assembly air cooling for cooling and exhaust. The air intake vents are located on the side panels of the active drawer, towards the front of the drawer. Four intake vents are located on the left side, and two intake vents are located on the right (hinge) side. One exhaust vent is located on the rear panel.

4.0 CABLES

NOTE: This section is intended only for reference. Please refer to the cable drawings for pin-outs and construction detail.

R2WS basic accessory cable is:

Part Number	Name	Function
SEG46118266-301	KYBD/FSD Cable	Keyboard and serial trackball connectivity

In addition, the HRF Common 28 V Power Cable (SEG46115683-301) is needed to connect power to the HRF FSD. Figure 4-1 shows the basic system cabling.

R2WS test accessory cables are:

Part Number	Name	Function
SEG46118267-301	A/D Cable	Provides a loop-back for testing the J3 A/D, D/A, DIO interface
SEG46118268-301	USB/IEEE 1394 Cable	Breaks out USB and IEEE 1394 channels onto separate connectors
SEG46118269-801	WS2 Headset	Device for audio input/output
SEG46118270-301	A/V Cable	Breaks out audio onto one connector, video onto another
SEG46115490-301	RGB Breakout Cable	Breaks out Left video output and Right video output onto separate connectors for testing dual-screen output functionality
SEG46115492-302	WS RGB Cable	Video to Monitor, for use with the RGB Breakout Cable
SEG46117757-301	WS2 Ethernet Connector Saver	Acts as connector saver for connector J9 once it is connected and allowed to remain there.
SEG46117766-301	HRF Ethernet Crossover Cable	Allows Ethernet connectivity between two devices with Ethernet interfaces.

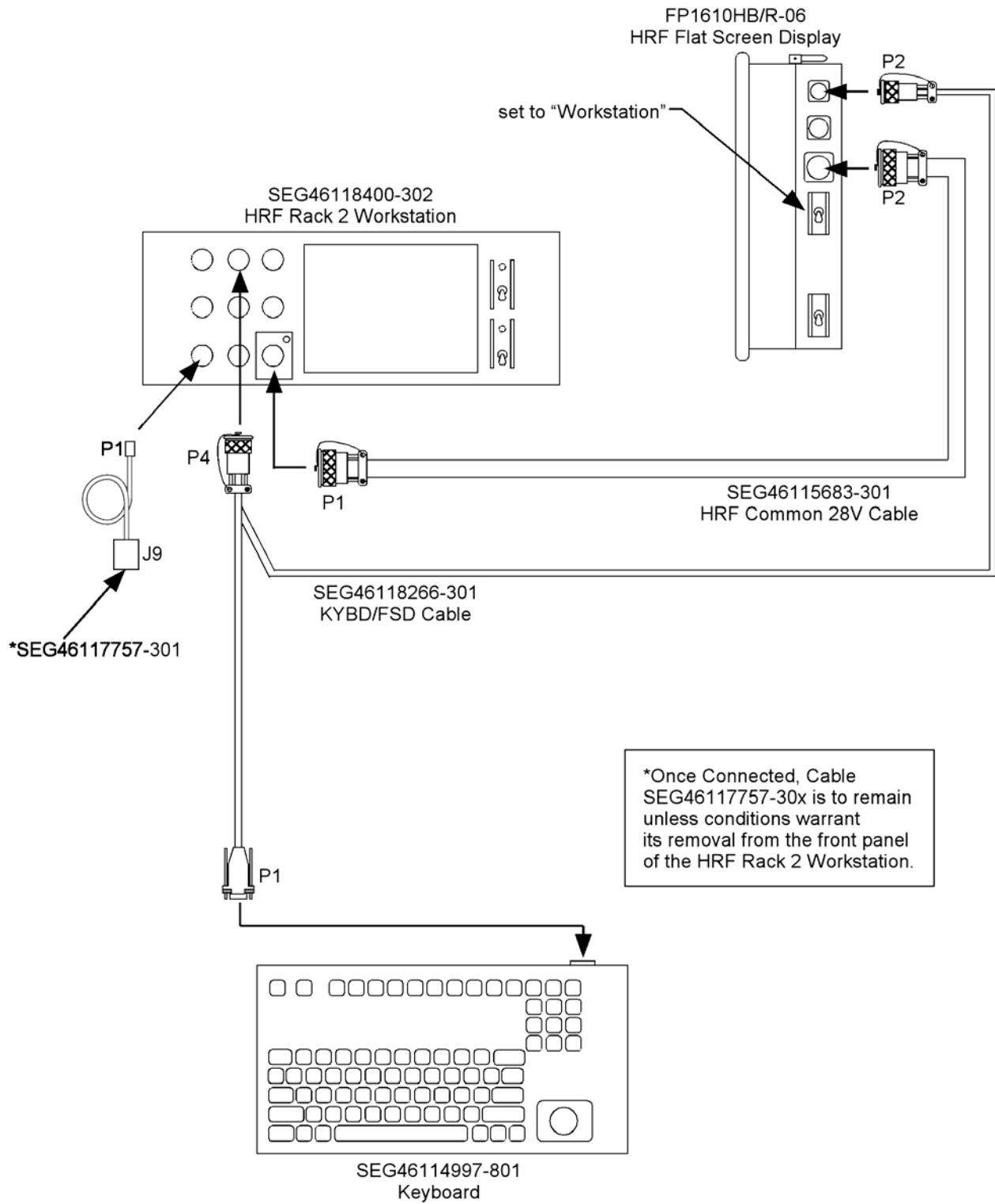
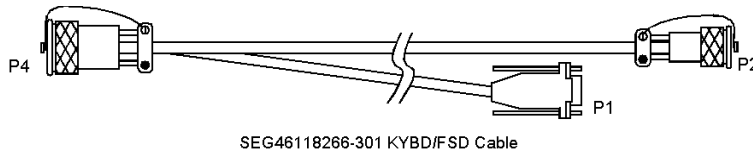

Figure 4-1. Basic System Cabling

4.1 VGA/KEYBOARD/MOUSE CABLE



Length: 84 ± 3 in. to FSD, 72 ± 2 in. to Keyboard	
Wire Gauge: 22 AWG	
Connector	Mates with
P4	J4 HRF R2WS front panel
P2	HRF FSD
P1	WS Keyboard

4.2 ANALOG-TO-DIGITAL LOOPBACK CABLE

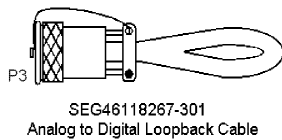

Length: 6 ± 2 in.	
Wire Gauge: 24 AWG	
Connector	Mates with
P3	J3 HRF R2WS Front Panel

4.3 USB/IEEE 1394 CABLE

SEG46118268-301
(TBD)

Length:	
Wire Gauge:	
Connector	Mates with
	J10 HRF R2WS Front Panel

4.4 WS2 HEADSET ASSEMBLY

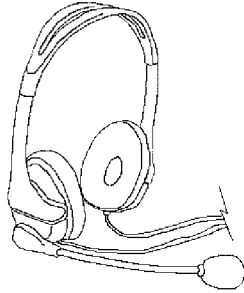

SEG46118269-801

Length:	72 ± 3 in.	
Wire Gauge:	28 AWG	
Connector	Mates with	
P5	J5	HRF R2WS front panel

4.5 A/V CABLE

SEG46118270-301
(TBD)

Length:		
Wire Gauge:		
Connector	Mates with	
	J5	R2WS front panel
	P5	R2WS Lightweight Headset

4.6 RGB CABLE

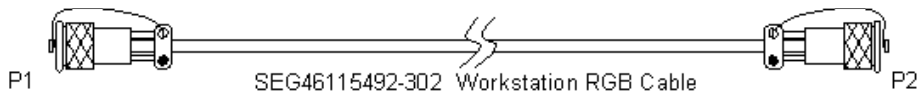

Length:	84 ± 5 inches end-to-end	
Wire Gauge:	22 AWG, stranded	
Connector	Mates with	
P1	J1	WS RGB Breakout Cable, or
	J2	WS RGB Breakout Cable
P2	HRF FSD	

4.7 RGB BREAKOUT CABLE

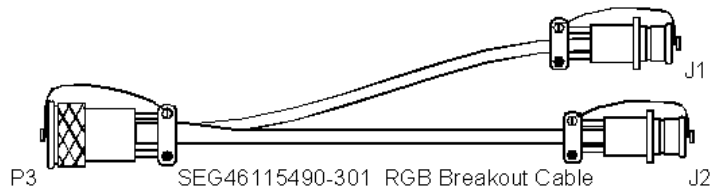

Length:	12 ± 1 inches end-to-end	
Wire Gauge:	22 AWG, stranded	
Connector	Mates with	
P3	J7	HRF R2WS Front Panel
J1	P1	WS RGB Cable
J2	P1	WS RGB Cable

4.8 WS2 ETHERNET CONNECTOR SAVER

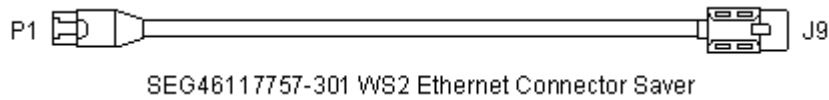

Length:	12 + 0.5 - 0 inches end-to-end	
Wire Gauge:	24 AWG, solid, bare copper, Cat 6	
Connector	Mates with	
P1	J9	HRF R2WS Front Panel
J9	HRF Common Ethernet Cable	

4.9 ETHERNET CROSSOVER CABLE

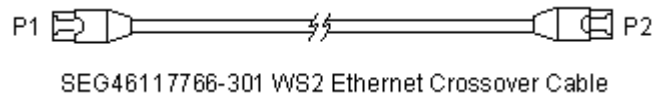

Length:	96 + 0.5 - 0 inches end-to-end	
Wire Gauge:	24 AWG, solid, bare copper, Cat 6	
Connector	Mates with	
P1	any industry standard Ethernet jack	
P2	any industry standard Ethernet jack	

5.0 HARDWARE DESCRIPTION

The HRF R2WS is a rack-mounted workstation computer with a Pentium®-class processor (minimum) and passive backplane that will serve as a general purpose experiment computer. The HRF R2WS supports a wide variety of experiment protocols across multiple disciplines. It provides data collection, archive, uplink, downlink, display, video processing, graphics acceleration, user interface, and HRF Rack interface.

The HRF R2WS interfaces include: Ethernet (10Base-T, 100Base-TX or 1000 Base-T), RGB video output (left and right eye capable), NTSC video in, one audio microphone input, one “line-in” audio input and two audio outputs for stereo capability, keyboard and pointing device interface, two IEEE 1394 channels, two USB channels, and A/D, D/A, and DIO. Expansion capabilities are provided by a dual-slot Personal Computer Memory Card Industry Association (PCMCIA) interface, and by using an internal design that allows removal/replacement of Small Computer System Interface (SCSI) devices and IDE devices of 3.5" format or smaller with no tools in flight.

The HRF R2WS uses a standard Operating System (OS), currently Microsoft Windows® 2000.

Operating System software, drivers, and software for testing R2WS functionality are provided.

The HRF R2WS will be used to provide a platform for installing and executing HRF and Principle Investigator (PI) S/W to perform the various tasks required in experiment procedures. These tasks include, but are not limited to: Command and Control (CnC) of HRF experiment equipment, monitoring of the HRF Rack and ISS (through an interface with the Rack Interface Controller (RIC)), experiment data collection and storage, crew notes, crew tests, and HRF equipment tests. The unit may also be connected to one or several experiment drawers within the same or another rack, or other HRF H/W to complete a specific configuration for a test or procedure.

The R2WS will require crew intervention and operation typical of similar applications involving computers in space. These include, but are not limited to, power cycling and booting, file maintenance, OS/user interface changes, routine cleaning and health checks, re-cabling and setup, and configuration changes such as swapping a hard drive, PC card, or connecting to an external storage device, printer, monitor or similar equipment.

The HRF WS display and keyboard will require routine operational handling, stowage, mounting, and movement about the payload area. Nylon hook-and-loop fasteners (commonly called Velcro®) will be placed in appropriate positions to facilitate mounting.

Cables for the keyboard and monitor are provided. Cables for experiment unique equipment will not be supplied.

5.1 RACK CONFIGURATION

The HRF R2WS is classified as a payload for the ISS.

5.1.1 Launch/Stowage Configuration

For launch and landing, the HRF R2WS computer drawer will be installed in an HRF Rack location. Other R2WS items (cables, archive media, display, and keyboard) will be stowed in a stowage drawer or similar secure location.

5.1.2 Deployed Configuration

During on-orbit operations, the HRF R2WS Computer Drawer will stay in its launch location (a 4-PU active drawer HRF Rack location) for operation. Stowed R2WS items (cables, archive media, display, and keyboard) shall be stowed in a stowage drawer or similar secure location when not in use; else they will be either mounted on the Seat Track Rail with a custom-built mounting arm assembly and/or connected as per operational requirements.

5.2 HARDWARE PRIMARY COMPUTER BOARD ASSEMBLIES

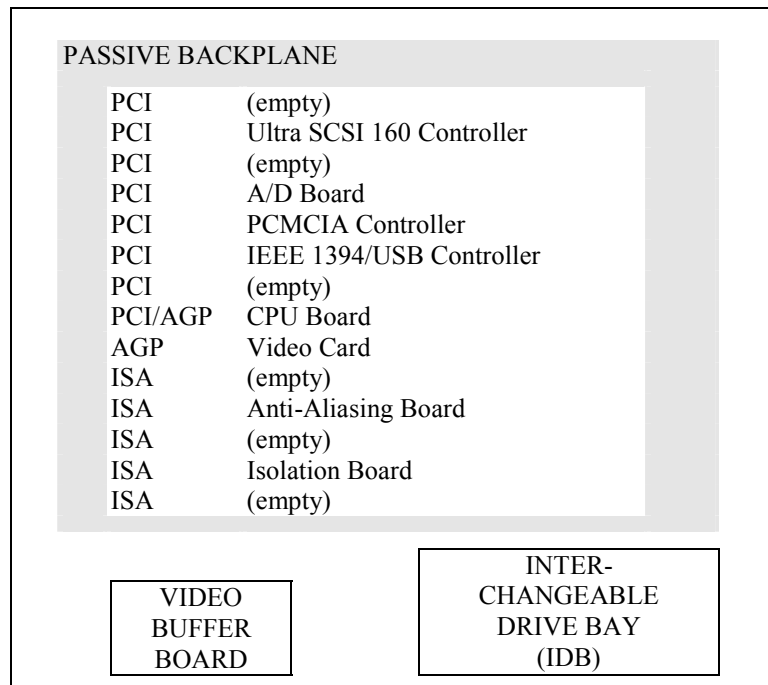

Figure 5-1. HRF R2WS Computer Boards

5.2.1 Summary of HRF R2WS Computer Drawer Hardware Components

Table 5-1 shows the boards contained in the HRF R2WS.

TABLE 5-1. HRF R2WS COMPUTER PWB ASSEMBLIES PART NUMBERS

Board	Manufacturer	Part Number
Ultra 160 SCSI Controller	Adaptec [®] , Inc.	29160N
Video Card	Tyan Computer Corporation	100-434003
A/D Board	Data Translation	DT322
PCMCIA Controller	Primary Simulation, Inc. (psism.com)	PCD-RP-220E
IEEE 1394/USB Controller	Orange Micro [®] , Inc.	70HTL0060
CPU Board	ICP Electronics, Inc.	SAGP-865EVG
Passive Backplane	ICP Electronics, Inc.	PXAGP-13S
Anti-Aliasing Board	Alligator Technologies	AAF-3M
Isolation Board	Lockheed Martin Space Operations	SEG46117753-301
Video Buffer Board	Lockheed Martin Space Operations	SEG46117764-301

5.2.2 Passive Backplane

The passive backplane is manufactured by ICP Electronics, Inc. It has four industry standard architecture (ISA) slots, seven PCI slots, one ISA with PCI extension slot, one dedicated PXAGP processor slot with a PCI extension connector and one AGP slot. The ISA bridge module P/N PISA-KIT01 is required to interface the ISA bus with the processor slot.

5.2.3 Central Processing Unit Board (AGP/PCI Card)

The AGP/PCI CPU board is manufactured by ICP Electronics, Inc., model SAGP-865EVG. It must be used with a PCIAGP/PXAGP series backplane made by ICP Electronics, Inc. Its features include the following:

- Intel[®] Pentium[®] 4 Processor running at 3.2 GHz (800 MHz bus, Hyper-Threading, 512 KB L2 cache), Hyper threading is disabled on the R2WS.
- Intel[®] 865G/ICH5 Chipset
- One Gigabyte (GB) of Synchronous Dynamic Random Access Memory (SDRAM) 64-Bit wide dual DDR (Maximum memory is 2 GB)
- AGP interface supporting 0.8/1.5V signaling with 8X/4X data transferring. (Does not support 3.3V AGP.) This board must be installed in a compatible ICP Electronics, Inc. backplane.
- Award Basic Input/Output System (BIOS)
- Eight MHz 16-bit ISA bus; 33 MHz 32-bit PCI bus; 100 MHz system and memory buses
- Seven DMA channels and fifteen interrupt levels
- On-board lithium battery, expected life is ten years
- Power requirements: +5 V @ 7 A, +12 V @ 7.5A, -12 V @ 0.5A

Ports:

- One PCI 10/100Base-T Ethernet port
- One 100/1000 Base-T Ethernet port
- Seven USB 2.0/1.1 ports; only three are used
- Two serial ports each supports up to 115.2 Kbps rate.
- Two PCI Enhanced Integrated Drive Electronics (EIDE) hard drive interfaces, each supports Ultra DMA/100.
- PS/2 keyboard and mouse connector (note that PS/2 mouse interface is not provided by the R2WS)
- Audio port, AC '97 Audio CODEC

Other ports available but not used by the R2WS:

- Floppy drive, parallel port, Serial ATA, IrDA and Compact Flash Storage card Type I/II connector

5.2.4 Anti-Aliasing Board (ISA Board)

The Anti-Aliasing Board is manufactured by Alligator Technologies, Inc. The board consists of:

One each AAF-3M carrier board

Two each AAF-3G two-channel amplifier modules

Two each AAF-2F/HC-B two-channel eight-pole elliptic filters

This combination allows amplification and filtering of up to eight channels.

Section 3.2.2.1 includes a brief description of the board, and Table 3-4 includes its specifications.

If a different filter is desired, a change request (CR) may be submitted to the Configuration Control Board (CCB). If approved, the hardware filter modules may be changed out prior to delivery.

5.2.5 IEEE 1394/USB Controller (PCI Card)

The IEEE 1394/USB controller card is manufactured by Orange Micro[®], Inc., model OrangeLink+FireWire/USB. The card has two IEEE 1394 ports and two USB ports, and provides up to 15 W of power for devices. Currently, the USB ports from this card are not being used. The features include:

IEEE 1394 Ports

- OHCI-Link and Physical Layer (PHY): NEC single chip; 100 Mbit/s (12.5 MB/sec); 200 Mbit/s (25 MB/sec); 400 Mbit/s (50 MB/sec)
- Connect up to 63 devices
- Up to 16 consecutive cable hops of 4.5 meters (m)

- Plug-and-Play (PnP) and Hot Plug
- Complies with Standard for a IEEE 1394 High Performance Serial Bus/ i.LINK
- Support for digital video in full size, full motion video of 720 by 480 pixels at 30 FPS
- Isochronous and Asynchronous data transfer
- Function Control Protocol (FCP)
- Connection Management Protocol (CMP)

5.2.6 Ultra 160 SCSI Controller (PCI Card)

The Ultra 160 SCSI controller card is manufactured by Adaptec[®], Inc. This 32-bit PCI card supports a data transfer rate of up to 160 MB/sec in Low-Voltage Differential (LVD) mode. It also features Cyclic Redundancy Check (CRC) and domain validation for data integrity and reliability. This card is compatible with legacy devices and will support single-ended mode (which results in slower data transfers.)

This card is preset to SCSI ID7 for highest priority on the SCSI bus; device IDs 0 through 6 and 8 through 15 are supported. Narrow (8-bit) SCSI devices should use SCSI IDs in the 0-6 range. The SCSI BIOS has been set to not scan for SCSI IDs 0-3 and 7-15 during boot up.

This card provides the SCSI interface in the Interchangeable Drive Bay (IDB). The card is specified to support total cable lengths of up to 12m (39.4 ft.) for Ultra 160 SCSI; 3m (9.8 ft.) for Fast SCSI up to seven devices and Ultra SCSI for up to four devices; 1.5m (4.9 ft.) for Ultra SCSI up to eight devices. These cable parameters have not been tested with the IDB. Internally, there are up to 20 in. of cable from the card to the IDB circuit board. Properly designed/constructed cables are required to achieve maximum performance.

5.2.7 Analog-to-Digital Board (PCI Card)

The A/D board is manufactured by Data Translation, Inc. The board is capable of high-speed burst data transfers by using bus master data transfers to a block of reserved memory. The board features 16-bit resolution on analog input and output channels. The two serial, multiplying analog output channels have a range of ± 10 V.

Analog input channels are bipolar and have independently programmable gains and can be sampled non-sequentially. Acquisition can be a single sample from a single channel or multiple samples from multiple channels. Multiple channel acquisition can be accomplished with either continuous scanning or triggered scanning. With triggered scanning, the channels are scanned at high speeds with programmed intervals between scans, thereby emulating scan-and-hold.

Two onboard 24-bit counter/timers with 20 MHz oscillators provide clocking and triggering. Trigger modes can be pre-trigger, post-trigger, and about trigger. Triggering can also be from an external source. In addition, there are four 16-bit user counter/timers. The duty cycle, frequency, and output polarity are programmable, and two counters can be cascaded through S/W.

The board has DIO lines. Two lines for input and two lines for output are made available at the R2WS front panel.

5.2.8 Video Card (AGP Card)

The AGP video card is manufactured by Tyan Computer Corporation, model Tachyon G9700 PRO.

The board supports multiple displays; settings are made using the included software. Assignment of primary and secondary displays are also done in software and does not require a re-boot.

The features include:

- ATI[®] RADEON™ 9700 PRO Visual Processing Unit (VPU) @ 325 MHz
- AGP 8X/4X/2X Support
- 128 MB DDR memory @ 310 MHz (620 MHz DDR)
- 256-bit memory interface
- Supports DirectX[®] 9.0 and the latest OpenGL[®] functionality
- Eight parallel rendering pipelines and four parallel geometry engines
- MPEG-2 decoding, all format DTV/HDTV decoding, 165 MHz TMDS transmitter (DVI 1.0 compliant)
- Optimized for Pentium[®] 4 SSE2
- VGA, S-video, and DVI-I connectors

Supported Screen Resolutions (monitor dependent):

<u>Display Resolution</u> (pixels)	<u>Color Depth</u>	<u>Refresh Rates</u>
800 x 600	16-bit, True Color	56 Hz, 60 Hz, 70 Hz, 72 Hz, 75 Hz, 85 Hz
1024 x 768	16-bit, True Color	60 Hz, 70 Hz, 72 Hz, 75 Hz, 85 Hz
1152 x 864	16-bit, True Color	60 Hz, 70 Hz, 75 Hz
1280 x 768	16-bit, True Color	56 Hz, 60 Hz, 75 Hz, 85 Hz
1280 x 960	16-bit, True Color	60 Hz, 70 Hz, 72 Hz
1280 x 1024	16-bit, True Color	60 Hz
1600 x 1200	8-bit, 16-bit, True Color	60 Hz, 70 Hz, 75 Hz, 85 Hz
1792 x 1344	8-bit, 16-bit, True Color	60 Hz, 75 Hz, 85 Hz
1800 x 1440	8-bit, 16-bit, True Color	60 Hz, 70 Hz, 75 Hz
1856 x 1392	8-bit, 16-bit, True Color	60 Hz, 72 Hz, 75 Hz, 90 Hz, 100 Hz
1920 x 1080	8-bit, 16-bit, True Color	60 Hz, 75 Hz
1920 x 1200	8-bit, 16-bit, True Color	60 Hz, 75 Hz, 100 Hz
1920 x 1440	8-bit, 16-bit, True Color	60 Hz, 75 Hz, 90 Hz
2048 x 1536	8-bit, 16-bit, True Color	60 Hz, 70 Hz, 75 Hz, 85 Hz

*True Color = minimum of 24 bits per pixel

5.2.9 PCMCIA Controller (PCI Card)

The PCMCIA card reader is manufactured by Primary Simulation Inc., model PCD-220E. The two 16-bit PC card sockets are compliant with PCMCIA 2.1/Japan Electronic Industry Development Association (JEIDA) 4.2 standards. It supports Types I, II and III PC cards, and is hot-swap compatible. NOTE: Microsoft Windows® 2000 may not support Static Random Access Memory (SRAM) cards.

The PCMCIA controller card controls the dual PCMCIA slots mounted in the IDB. See Section 5.2.12 for further description.

5.2.10 Isolation Board

The Isolation Board was developed by LMSO. The Isolation Board performs single-ended/differential conversions and optical isolation of various signals. The resettable fuses for power on connectors J7 and J8 reside on this board. See Figure A-2.

5.2.11 Video Buffer Board

The Video Buffer board was developed by LMSO. The Video Buffer Board allows one video signal to drive two displays. In the R2WS, the left-eye signal is routed through this board to the RGB connector (J7) and the VGA connector (J4).

5.2.12 Interchangeable Drive Bay

The IDB was developed by LMSO. The IDB supports up to two standard 3.5" IDE 1-inch high drives, three standard 3.5" SCSI one-inch high devices, and houses one two-slot PCMCIA drive. Access is through a door at the front panel. Devices greater than one-inch high can be accommodated, but it will decrease the total number of devices in the IDB.

The IDE interface of the IDB is provided by the Ultra DMA 100 interface on the CPU board. This interface supports up to Ultra-100 speeds. Each slot is connected to a separate controller, with the right slot on the primary controller, and the left slot on the secondary controller.

The SCSI interface is provided by the Ultra 160 SCSI controller (see Section 5.2.6); it supports Low-Voltage Differential (LVD) devices and single-ended devices. The bus direction is from right to left, with the left-most slot being the furthest away from the controller. The speed of the bus is as fast as the slowest SCSI device on the bus.

The IDB provides on-board multimode active termination. If there is a single-ended SCSI device on the bus, the SCSI bus will be in single-ended mode. Else it will be in LVD mode. The on-board terminator can be de-activated by setting Switch 1 of the Dual In-line Package (DIP) switch located on the board to "OPEN"; Switch 2 of the switch is not connected and has no effect.

The PCMCIA slots are compatible with Type I, II, and III PCMCIA Cards (PC Cards), and supports:

- Fax/modem cards, Ethernet cards, combination fax/modem, and Ethernet cards
- Sound cards, SCSI adapters, Compact Disc Read-Only Memory (CD-ROM) interfaces, security cards and other 16-bit PC cards with driver.
- Hot-swapping of PCMCIA devices

CAUTION: The IDB backplane does not support hot-swapping. Care must be taken to turn the computer power off prior to removing or inserting a device into the IDB backplane.

For Type III PCMCIA cards it is also possible to use the SEG46114886-303 Reader/Writer Assemblies. The Reader/Writer Assemblies must be set to ID 4, 5, or 6 only. The Reader/Writer Assemblies insert into one of the SCSI slots.

Accessories for the IDB are listed in Table 5-2.

TABLE 5-2. IDB ACCESSORIES

Part Number	Description
SEG46118264-301	Adapted IBM [®] IDE Drive P/N 07N3935 76.86 GB ATA-100
SEG46117767-30X x = 1, 2, or 3	Adapted IBM [®] SCSI Drive P/N 07N3200 36.7 GB Ultra 160
SEG46114886-303	Adapted PCMCIA Card Reader/Writer with SCSI-2 Interface, by MPL AG Elektronikunternehmen; set to ID 4, 5, or 6 only
SDG46114191-701	PCMCIA hard drive by Integral Peripherals, 340 MB

6.0 OPERATIONAL SCENARIOS

When the HRF R2WS is to be used, the keyboard and display must first be removed from stowage and connected to the R2WS computer drawer via front panel connectors. Alternatively, the R2WS may be used without the keyboard and is instead run from boot up ground commands. The display and keyboard must be attached to the Rack Seat Tracks with attachment brackets stowed elsewhere. A boot drive must be removed from stowage and installed in the IDB. When performing archive operations to the IDB, the archive media must be removed from stowage and installed in the IDB. When experiments are to be interfaced, experiments must supply the appropriate cables for interfacing via the HRF R2WS front panel connectors.

The Ethernet Connector Saver, P/N: SEG46117757-30x, should be mated to the R2WS front panel connector J9 and allowed to remain there. Ethernet connections are then made to J9 of the cable as needed; this serves to reduce mating cycles on the front panel connector itself.

For each application, the appropriate S/W package must be selected from the available set on the R2WS or from the ground. S/W setup, calibration, and initialization are application-specific. A basic load/user interface will be flown as standard.

APPENDIX A

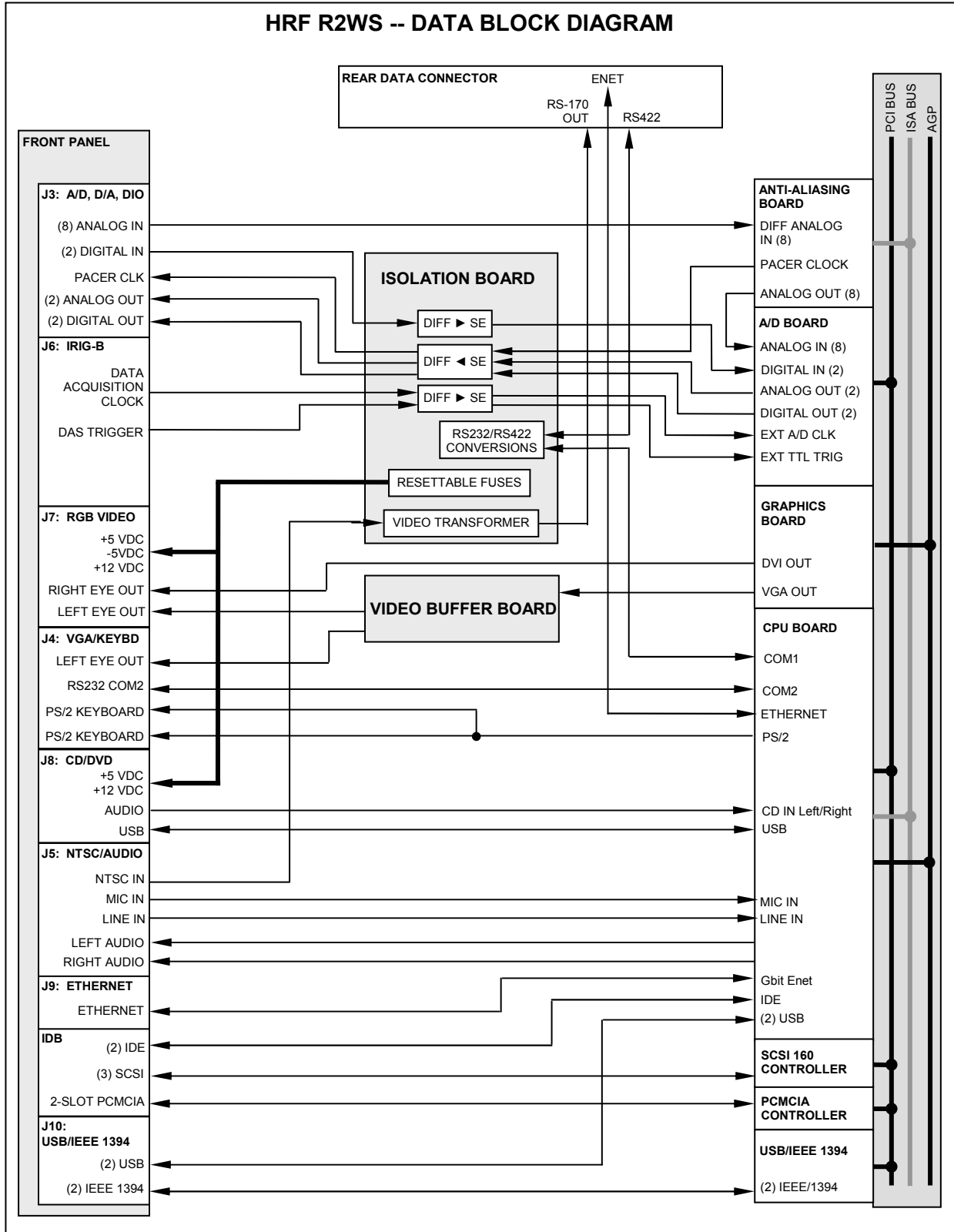

Figure A-1. R2WS System Block Diagram

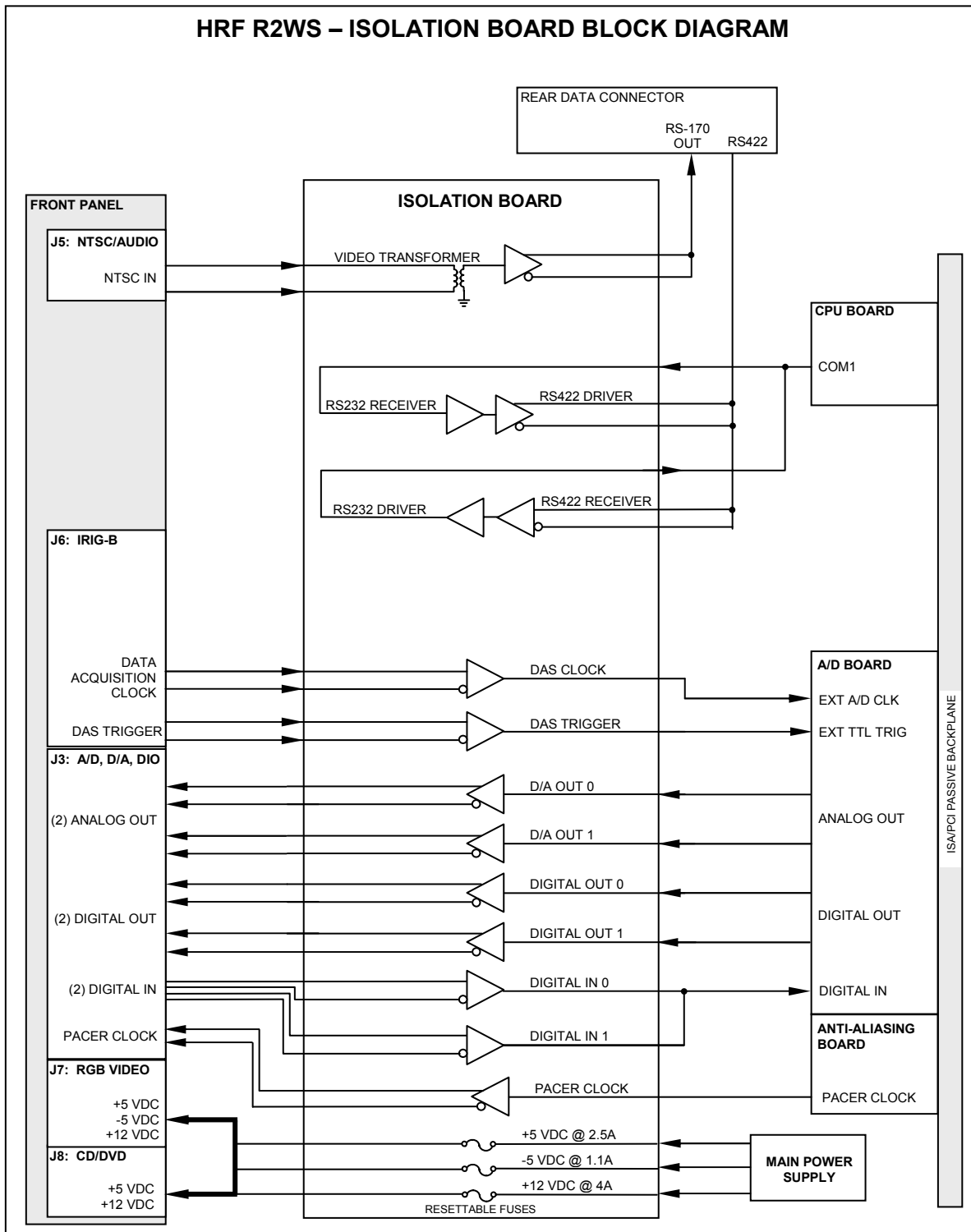

Figure A-2. R2WS Isolation Board Block Diagram

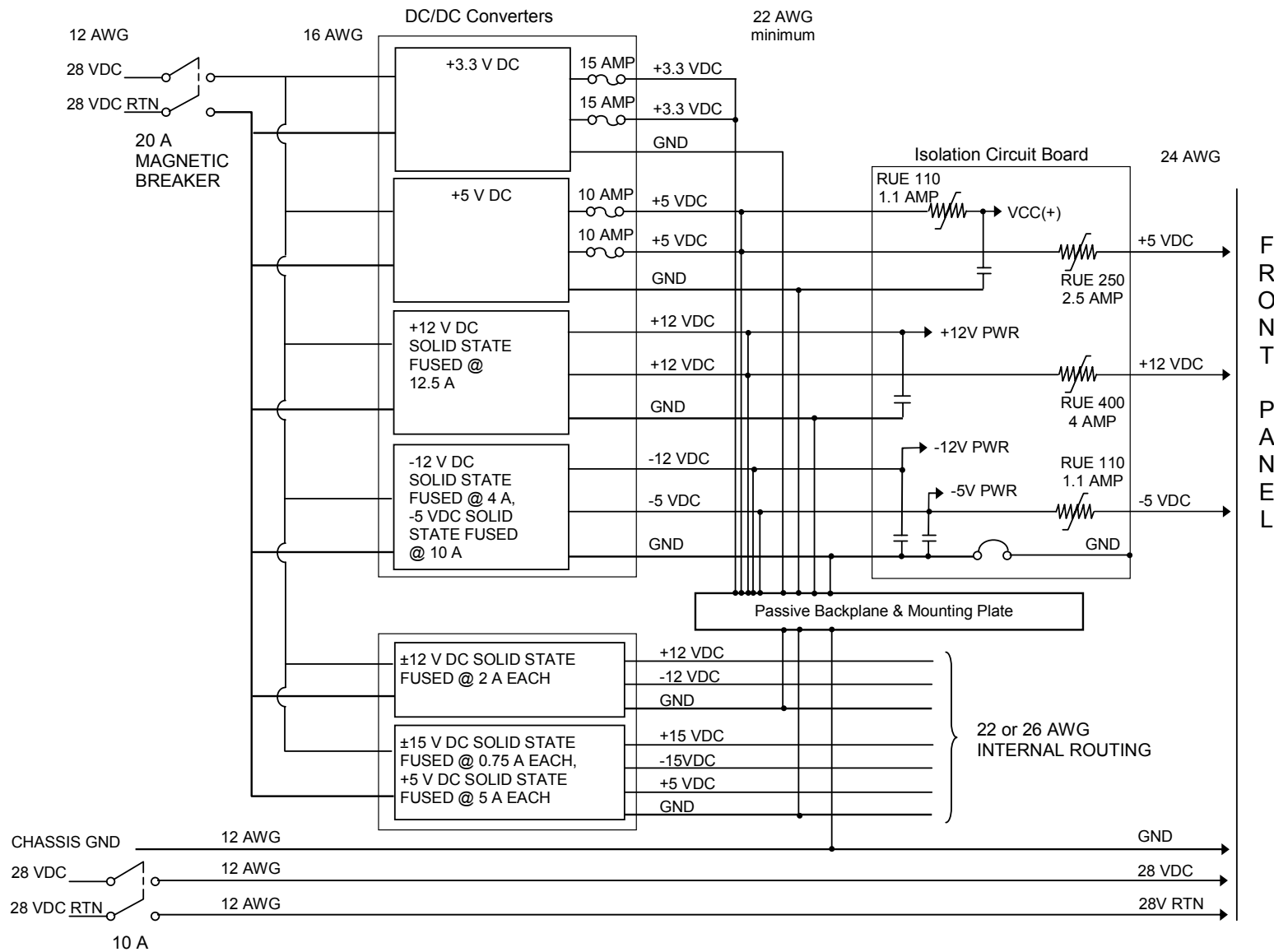

Figure A-3. Wiring and Fusing Diagram

DISTRIBUTION LIST
FOR
LS-71042-14-4B

TDI Center/Bldg. 36 (5)

EB/G. Valle
K. Tucker

LOCKHEED MARTIN

C42/Science Payloads Library

S22/K. Upham

S362/H. Charles

S362/J. Bejarano

S362/A. Leyman

S363/P. Nystrom